

Biežākās ergonomisko risku izraisītās arodslimības pārtikas ražošanas nozarē nodarbinātajiem – to izcelsme, tipiskākās sūdzības, agrīna pamanīšana darba vietās

Jeļena Reste, *Dr. med.*

arodveselības un arodslimību ārste, sāpju ārste
docente, vad. pētniece



RĪGAS STRADIŅA
UNIVERSITĀTE

VITA BREVIS ARS LONGA

14.06.2022.

Rīgas Stradiņa universitāte
Darba drošības un vides veselības institūts
Aroda un vides medicīnas katedra

Kopējā pirmreizējo arodslimnieku un arodslimību skaita dinamika Latvijā 1993.-2020. g.

(absolūtais skaits)

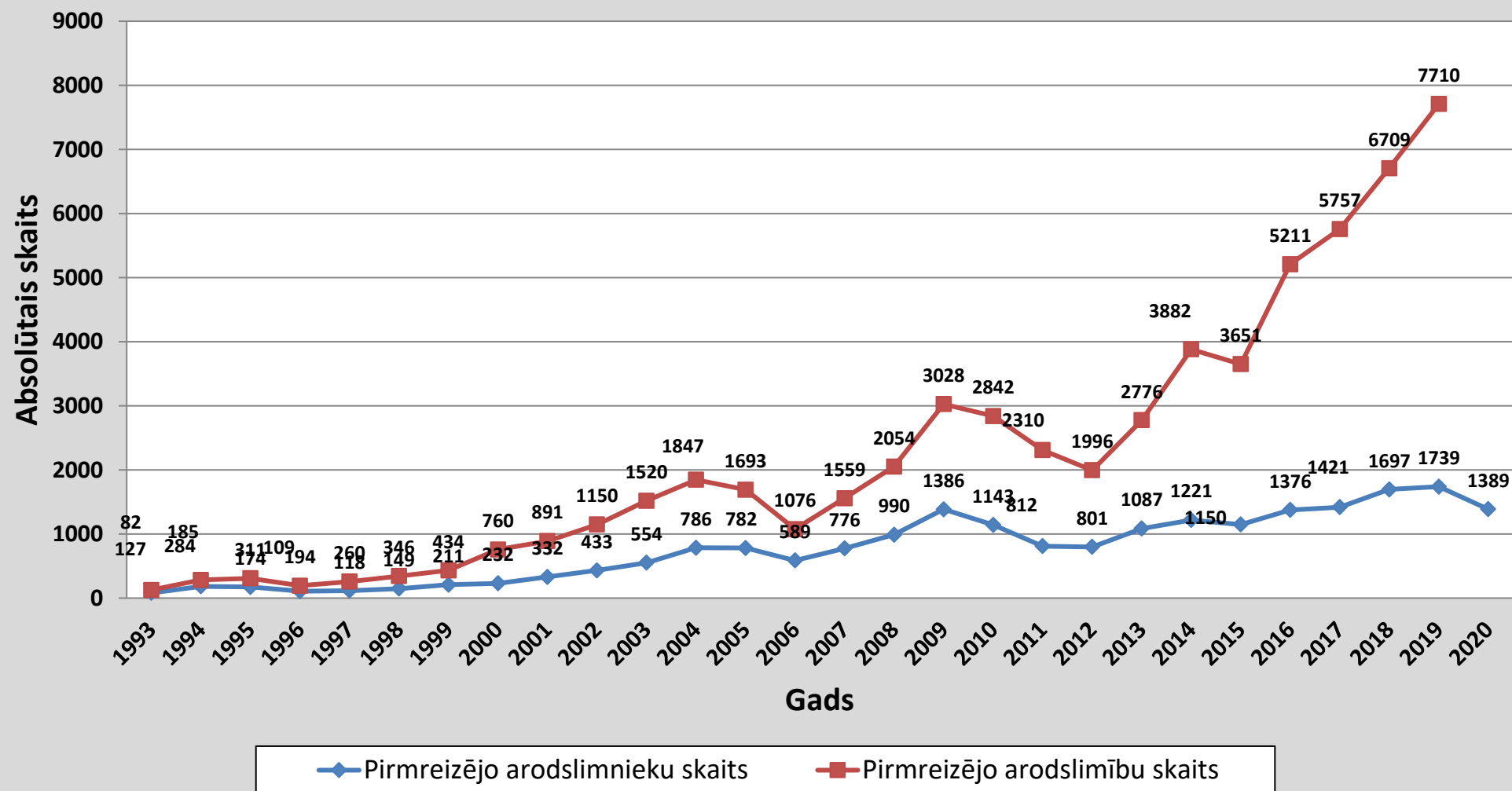

Arodslimnieku sadalījums pēc darbības veida 2020.g.

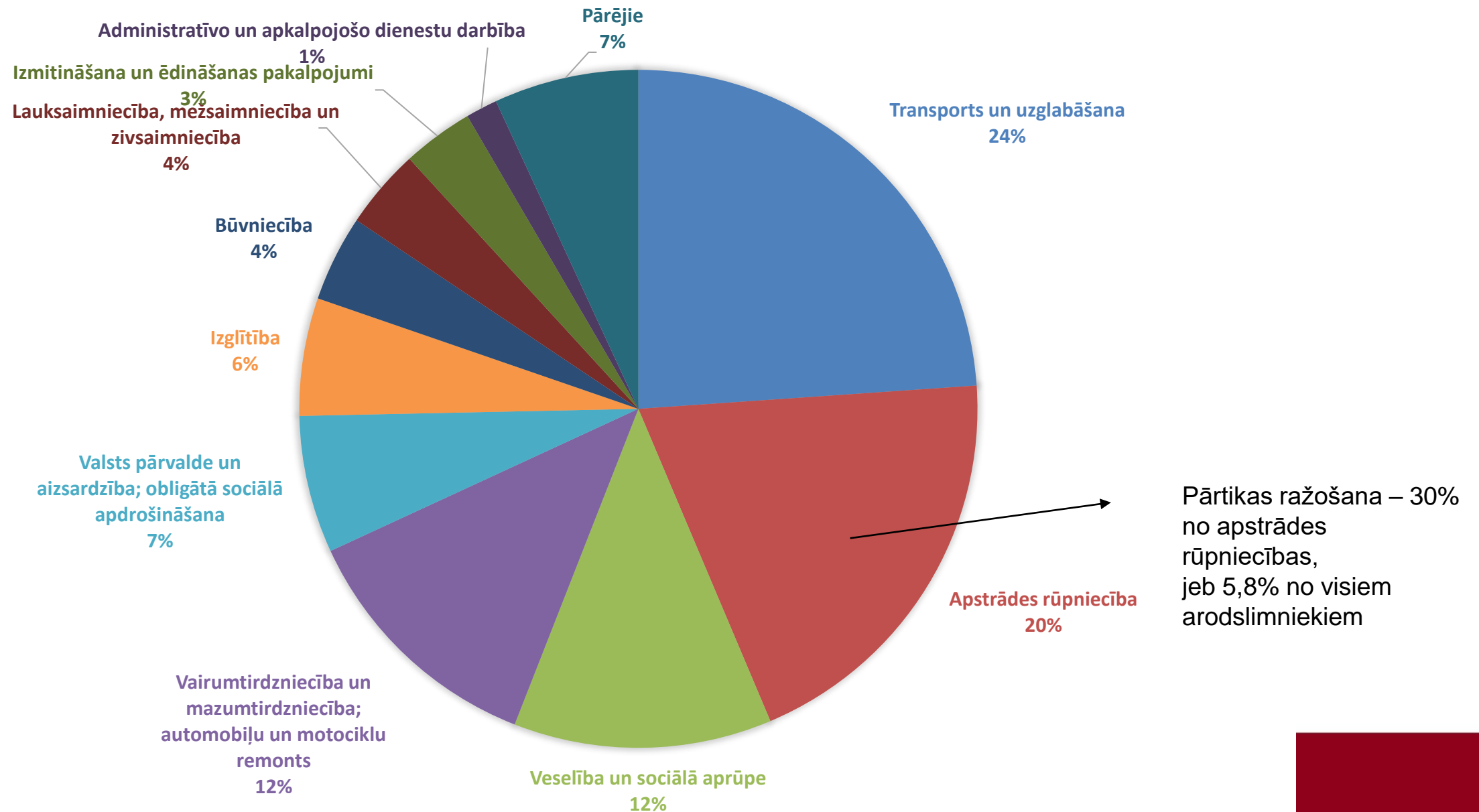

Arodslimību top 10 Latvijā

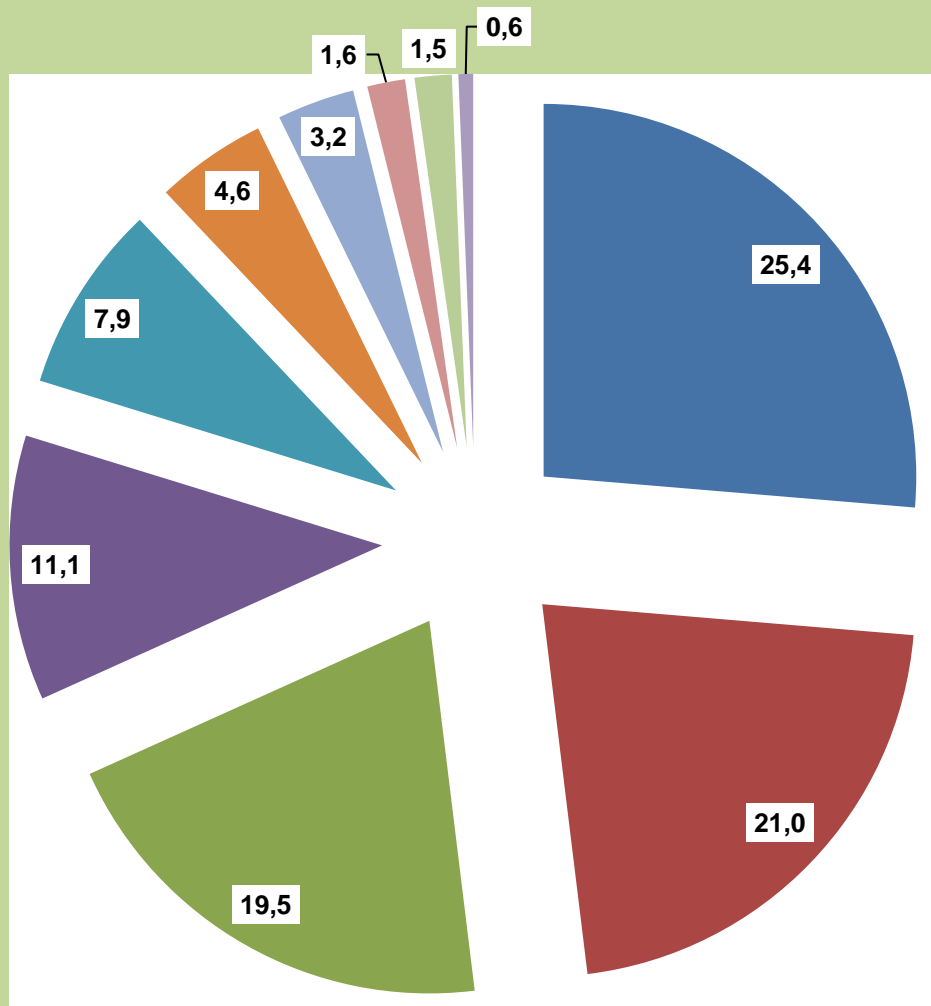

- Mugurkaula slimības
- Saistaudu slimības (tendinīti, Dipitrēna kontraktūra u.c.)
- Karpālā kanāla sindroms
- Artrozes
- Vibrācijas slimība
- Trokšņa izraisītā vārdzirdība
- Elpošanas orgānu slimības
- Vēnu varikoze
- Elkoņa nerva neiropātija
- Ādas slimības

Tipiskā arodslimnieka portrets Latvijā 21. gadsimtā

- Sieviete 54 gadu vecumā
- Kopējais darba stāžs 30 gadi
- Darba stāžs kaitīgu faktoru ietekmē 28 gadi
- Cieš no sāpēm mugurā un rokās (cīpslu iekaisumi, karpālā kanāla sindroms)
- Slimību izraisīja fiziskā pārslodze un slikta ergonomika
- Bija cietusi no sāpēm ilgstoši pirms tika reģistrēta arodslimība, taču turpināja strādāt, neko nemainot savā darbā

Nozīmīgākie darba vides ergonomiskie faktori pārtikas ražošanas nozarē strādājošajiem

■ Ergonomiskie riska faktori:

- » piespiedu darba poza,
- » neērta darba poza,
- » atkārtotas vienvēidīgas kustības,
- » ātras biežas kustības,
- » ātrs darba temps,
- » ergonomiski slikti iekārtota darba vieta,
- » atkārtota smagumu pārvietošana,
- » u.tml.



Pārslodzes izraisītie veselības traucējumi

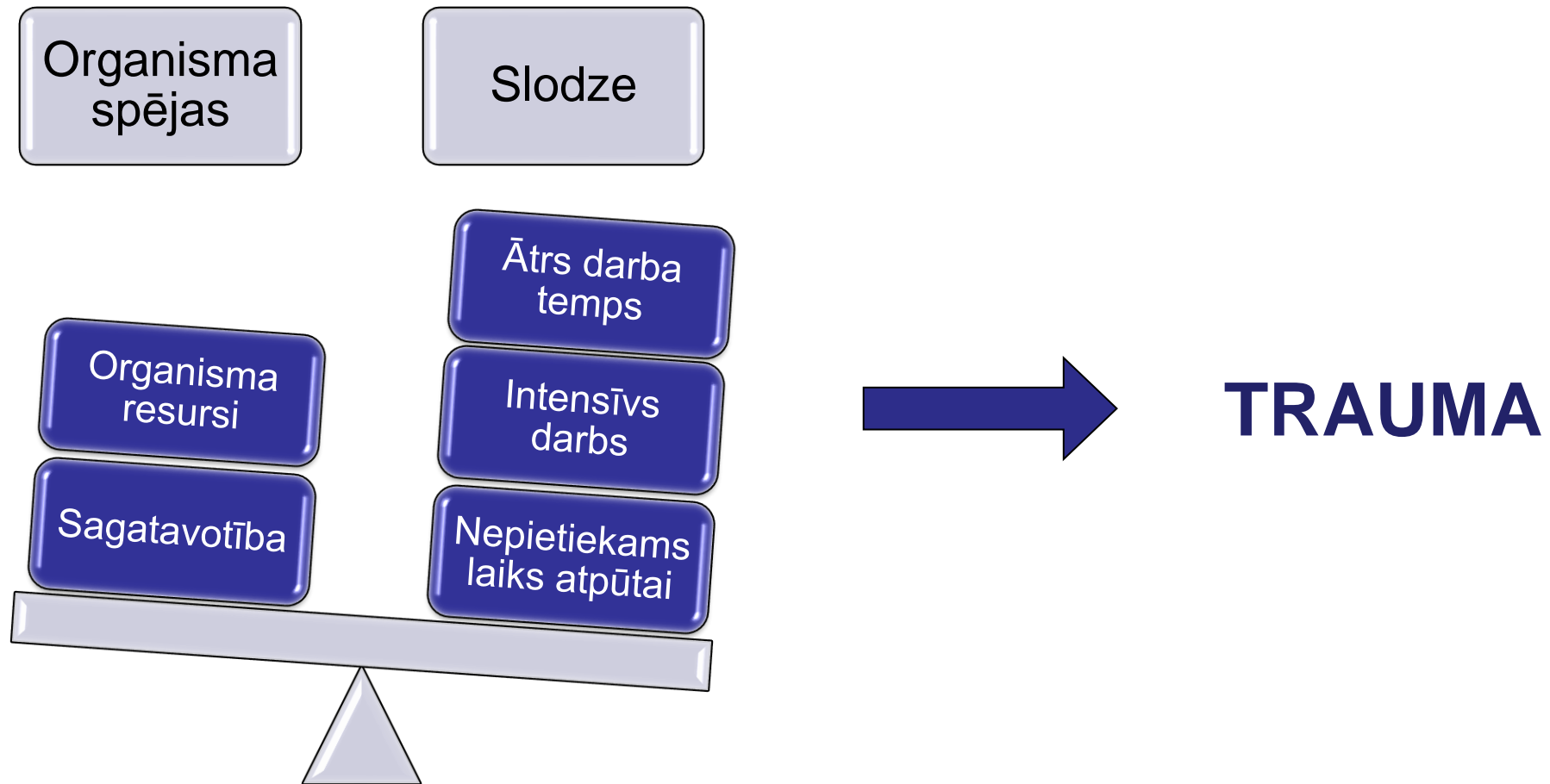

Plauksta cīpslu iekaisumi

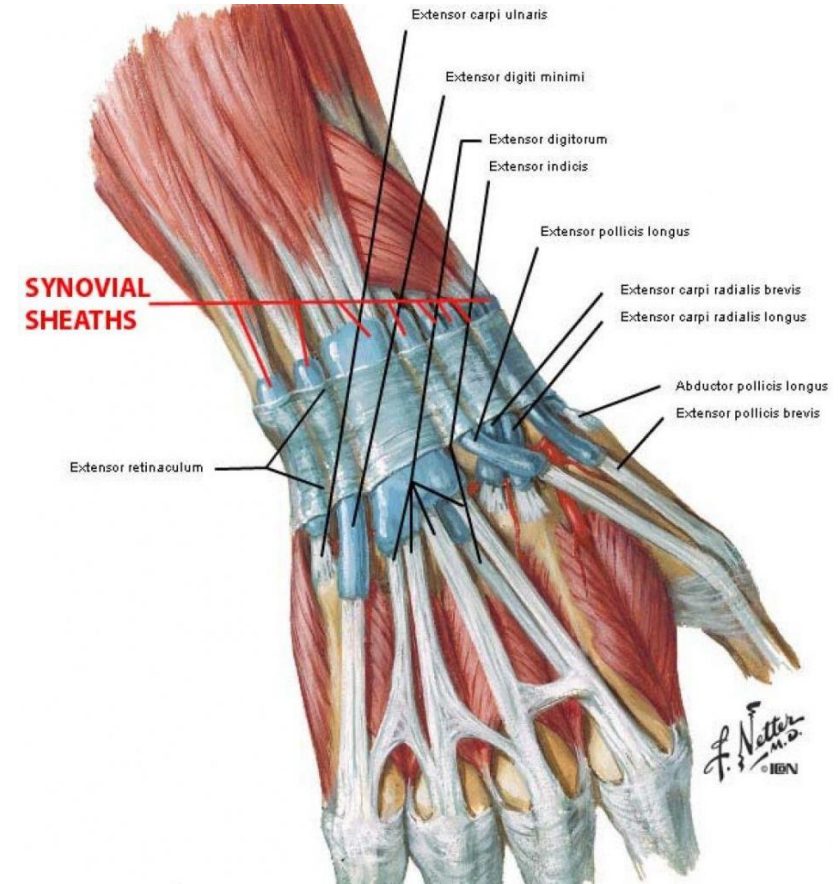
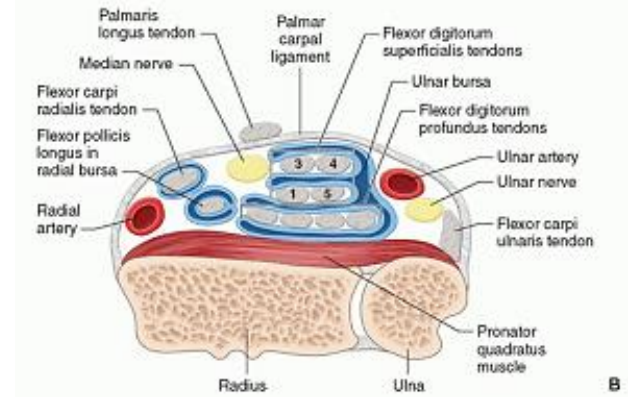
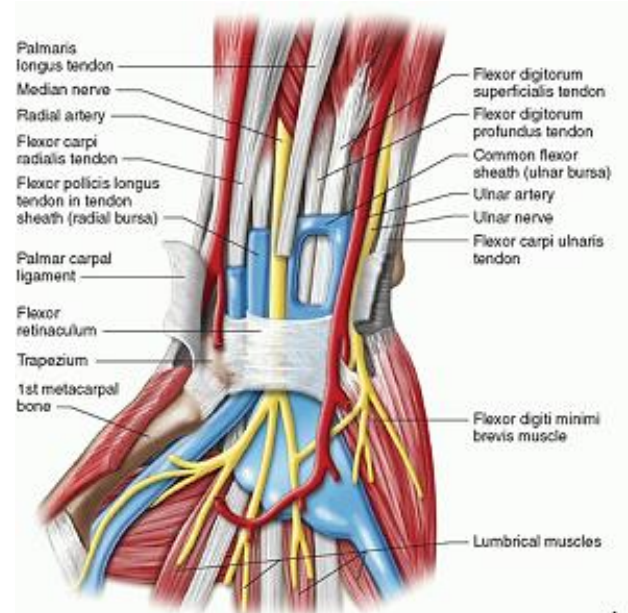
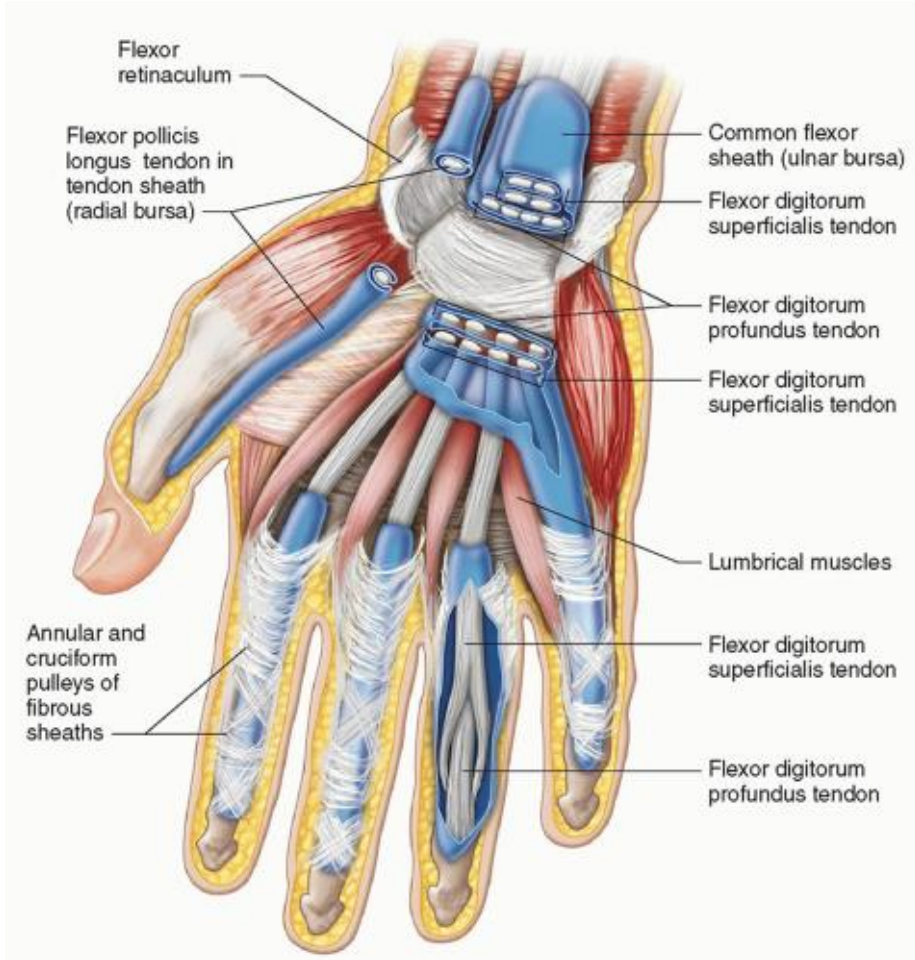



Karpālā kanāla sindroms

Cross-sectional anatomy of the wrist

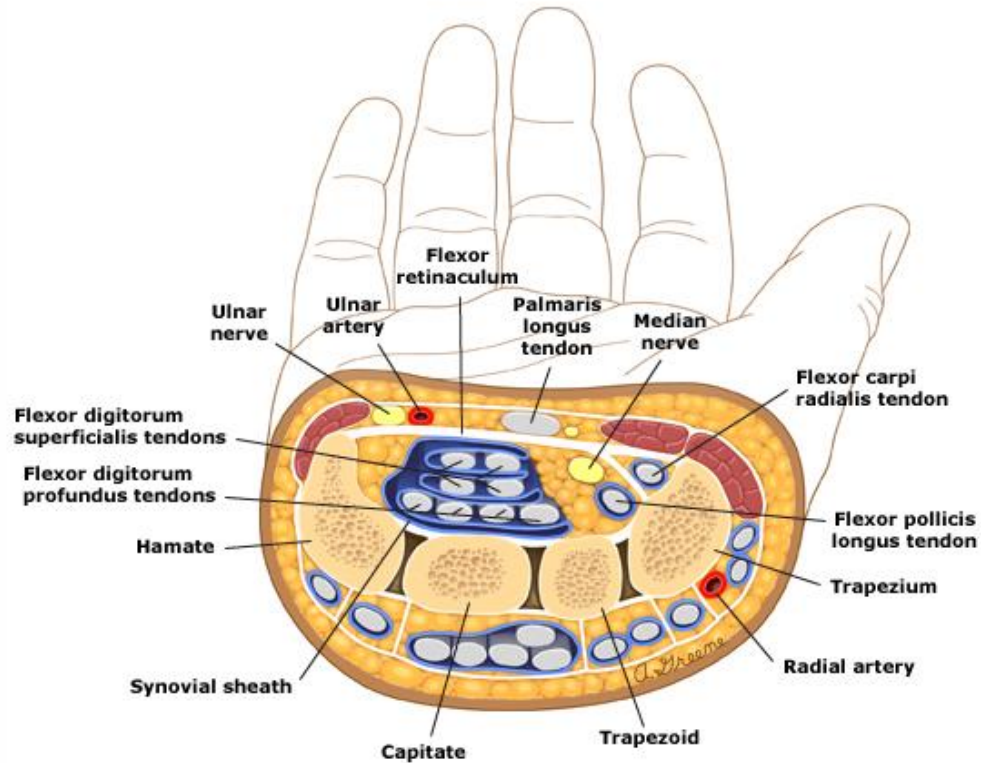

This figure represents a cross sectional view of the right wrist. Tendons and median nerve may be compressed by inflammation or infection because they are encompassed by synovial sheath and flexor retinaculum.

UpToDate®

Sensory territory of the median nerve

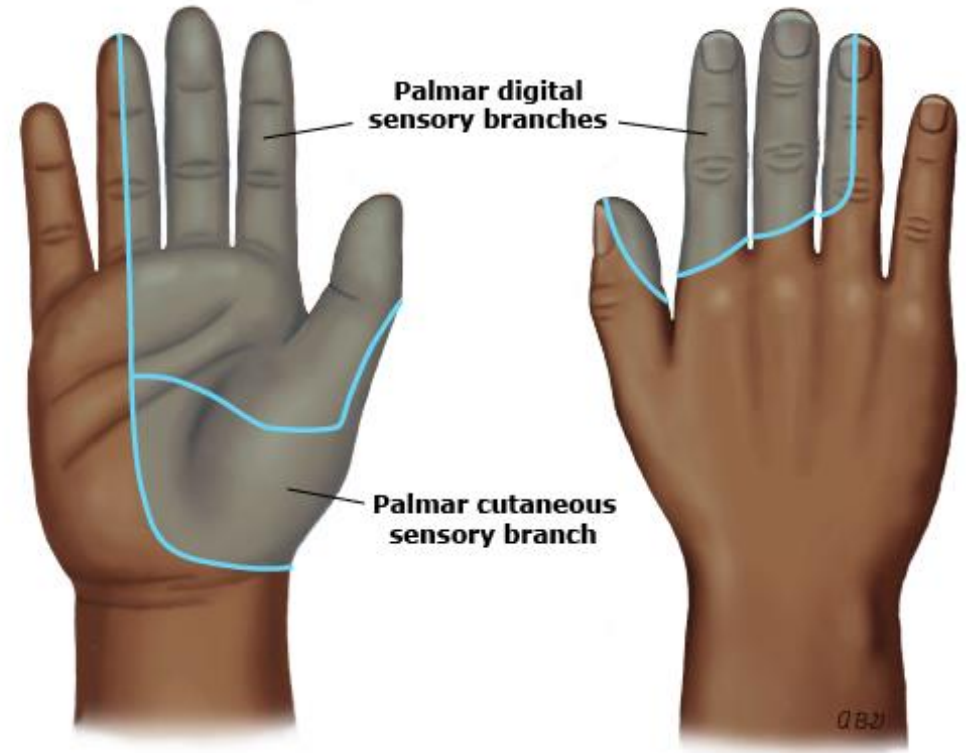

Modified from: Preston DC, Shapiro BE. Median neuropathy. In: Electromyography and neuromuscular disorders: Clinical-electrophysiologic correlations. Butterworth-Heinemann, Boston 1998.

UpToDate®

Palmārā fasciāla fibromatoze (Dipitrēna kontraktūra)



Stage A



Stage B



Stage C

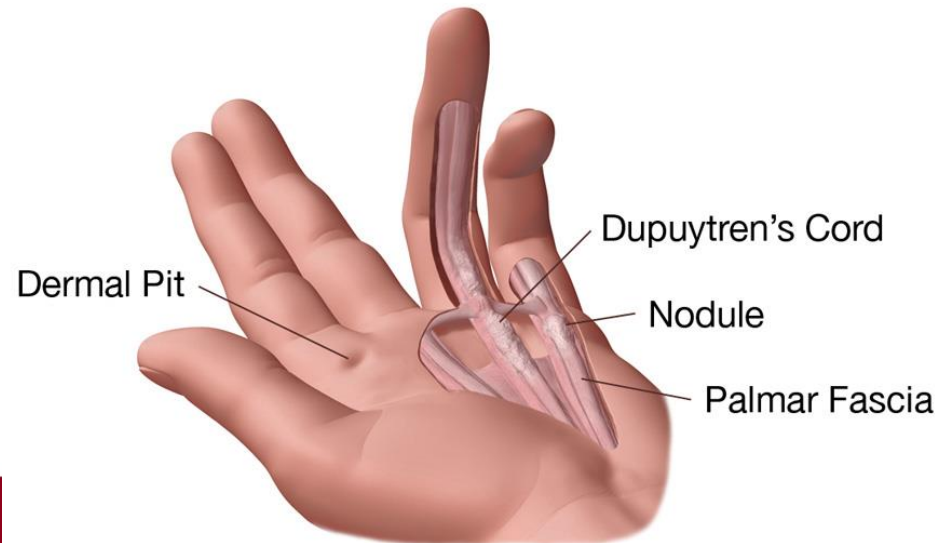

Mediālais un laterālais epikondilīts

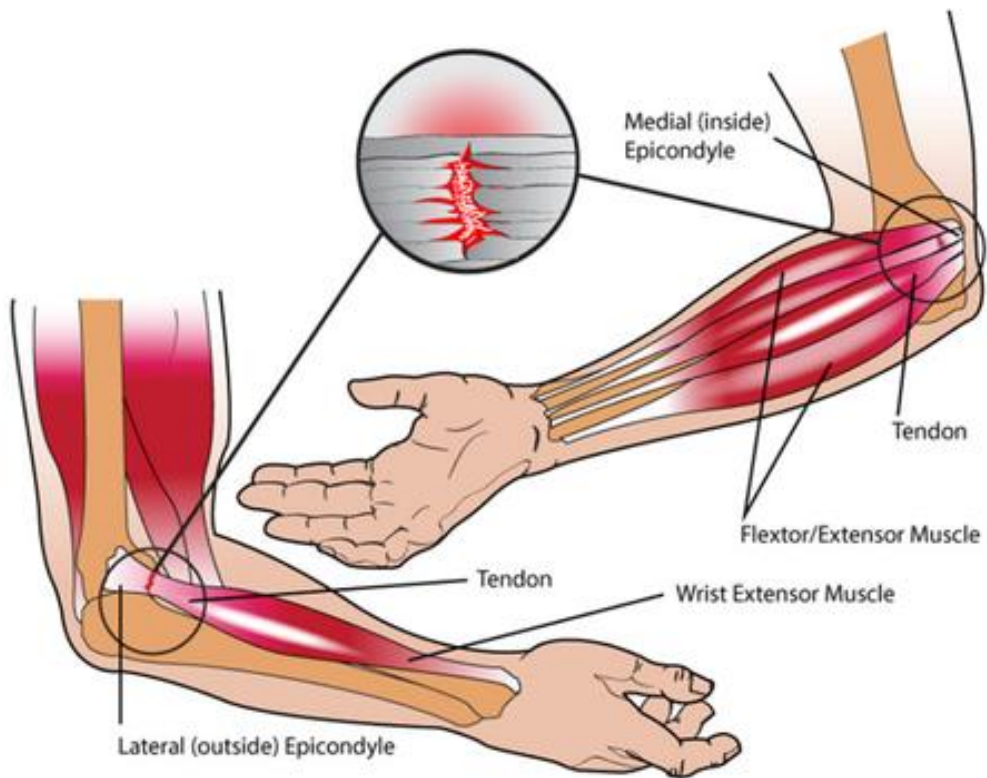

Pleca locītavas cīpslu iekaisumi un bojājumi

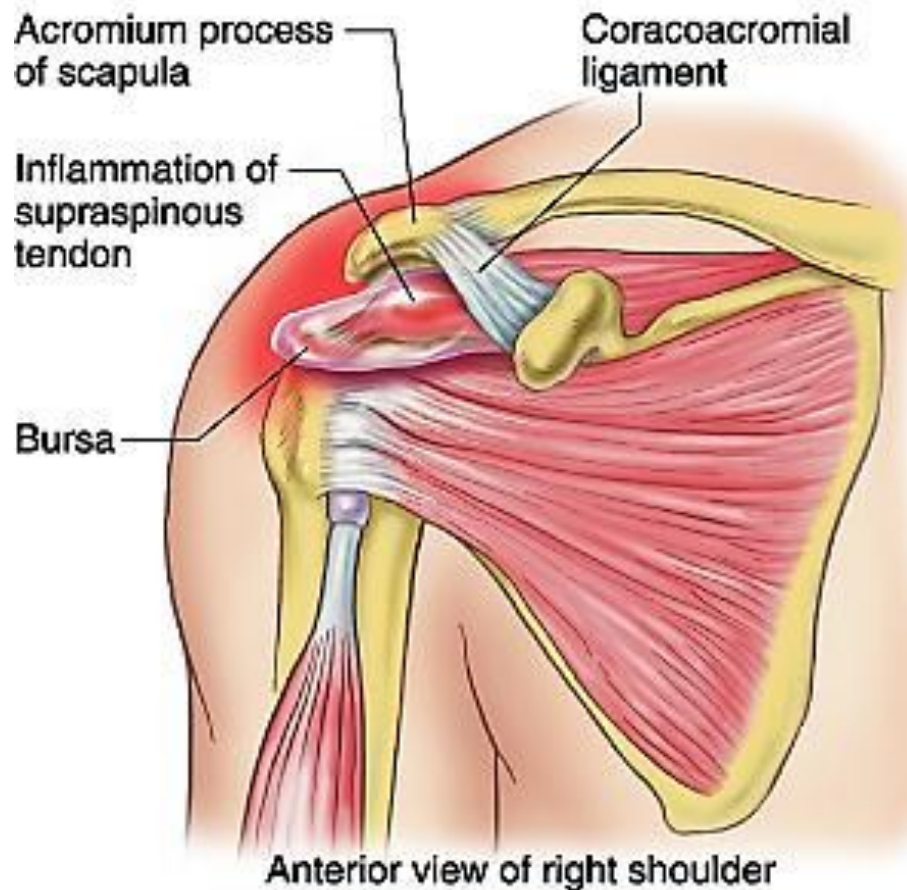

Sāpes sprandā

Cervical Radiculopathy

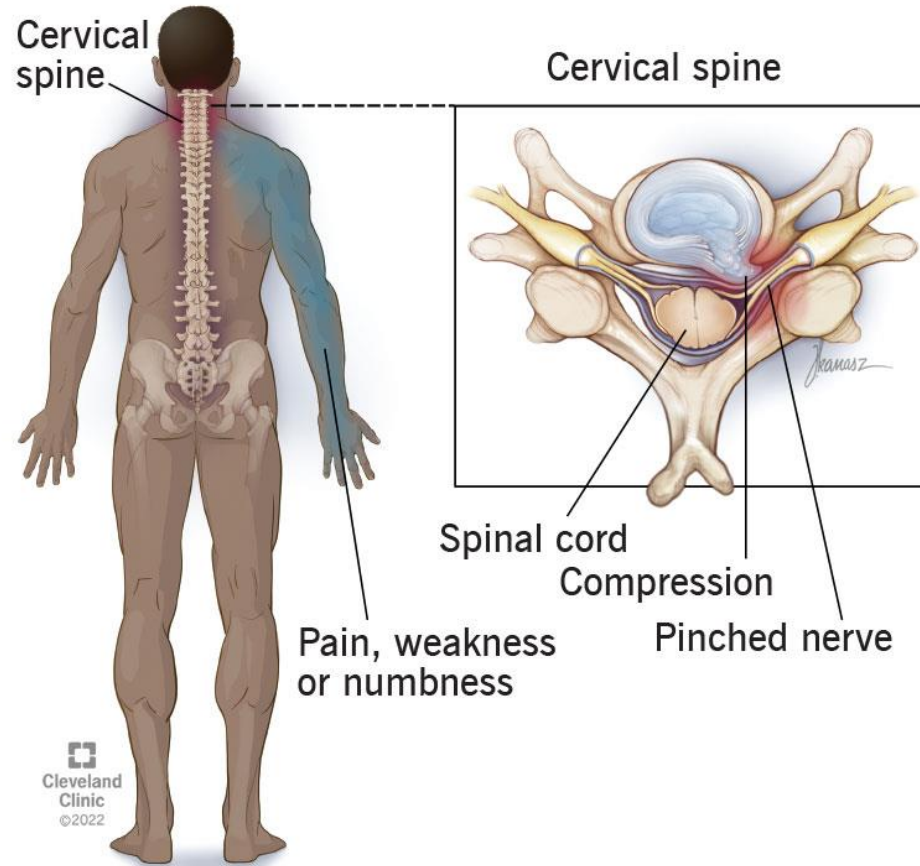

Sāpes muguras lejasdaļā

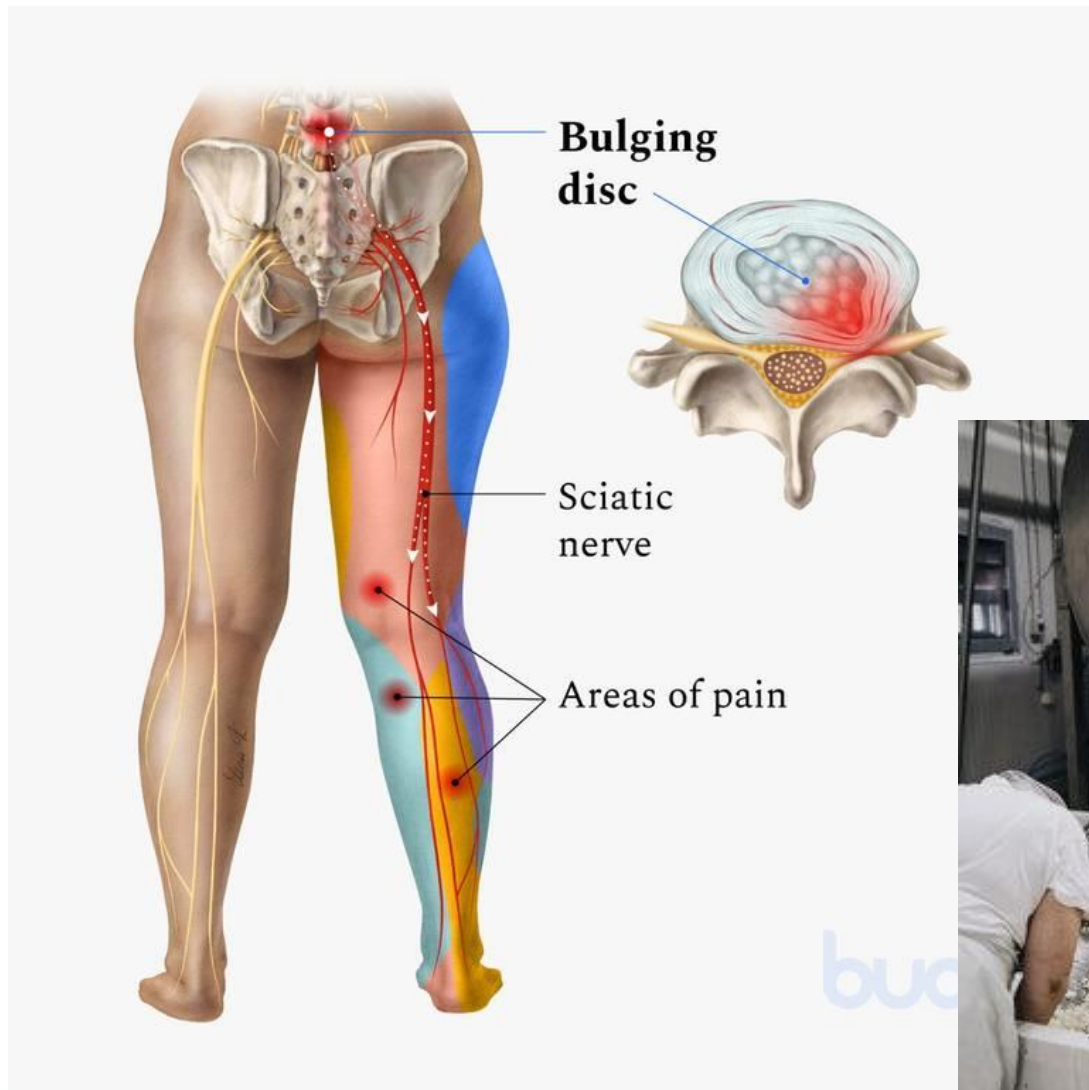

Slodze uz mugurkaula jostas daļu atkarībā no pozas

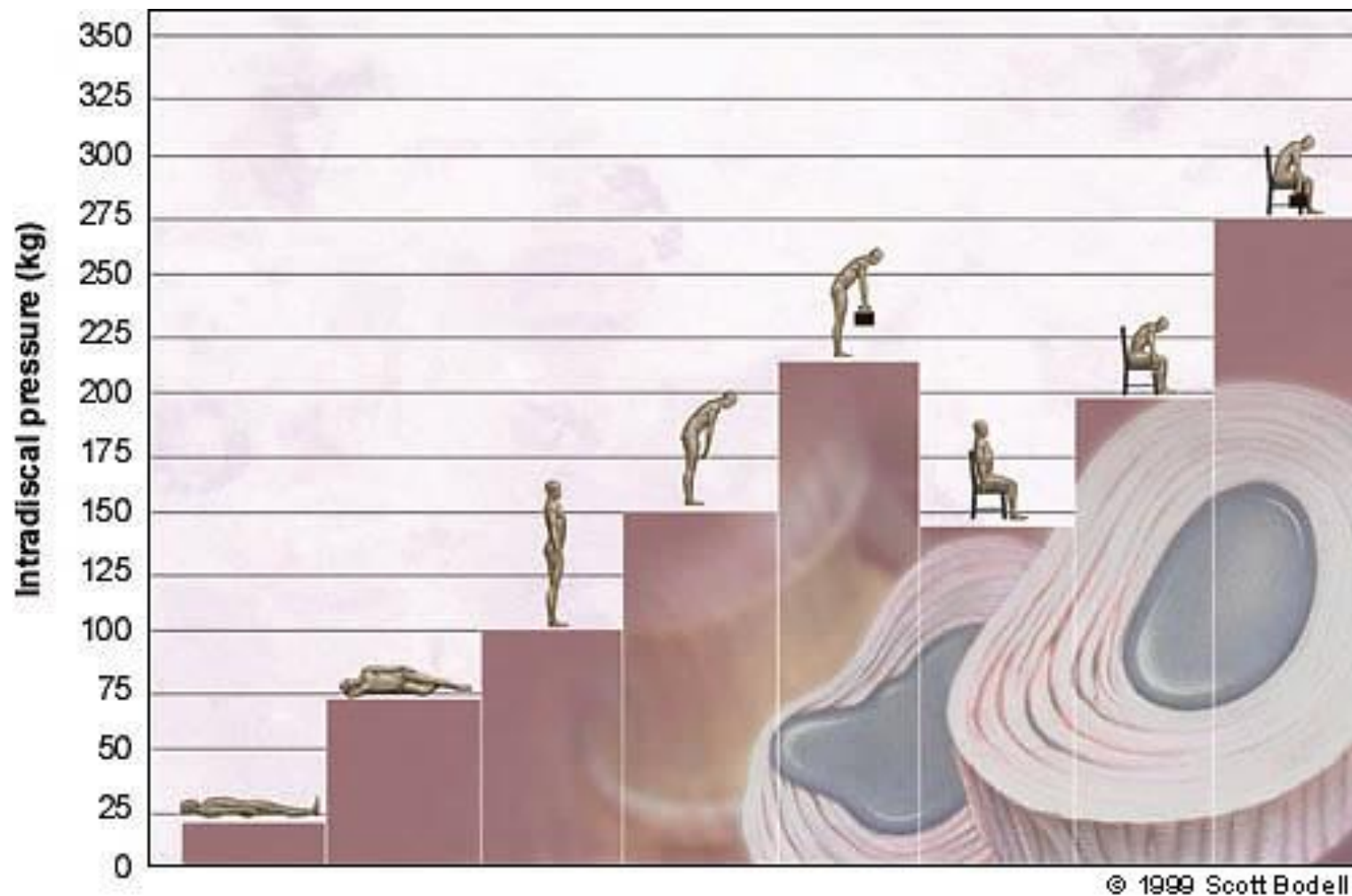

«Apaļas» muguras efekts



<https://www.researchgate.net/profile/William-Keyserling/publication/8093594/figure/fig7/AS:277781742145547@1443239736369/Placing-corrugated-cases-into-the-bottom-of-a-triwall-is-associated-with-awkward-trunk.png>

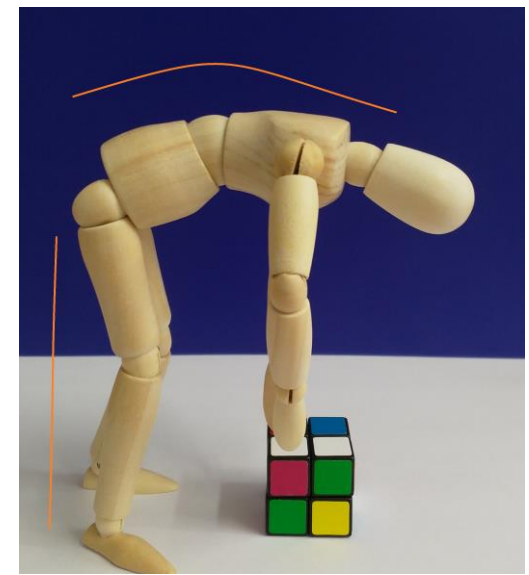
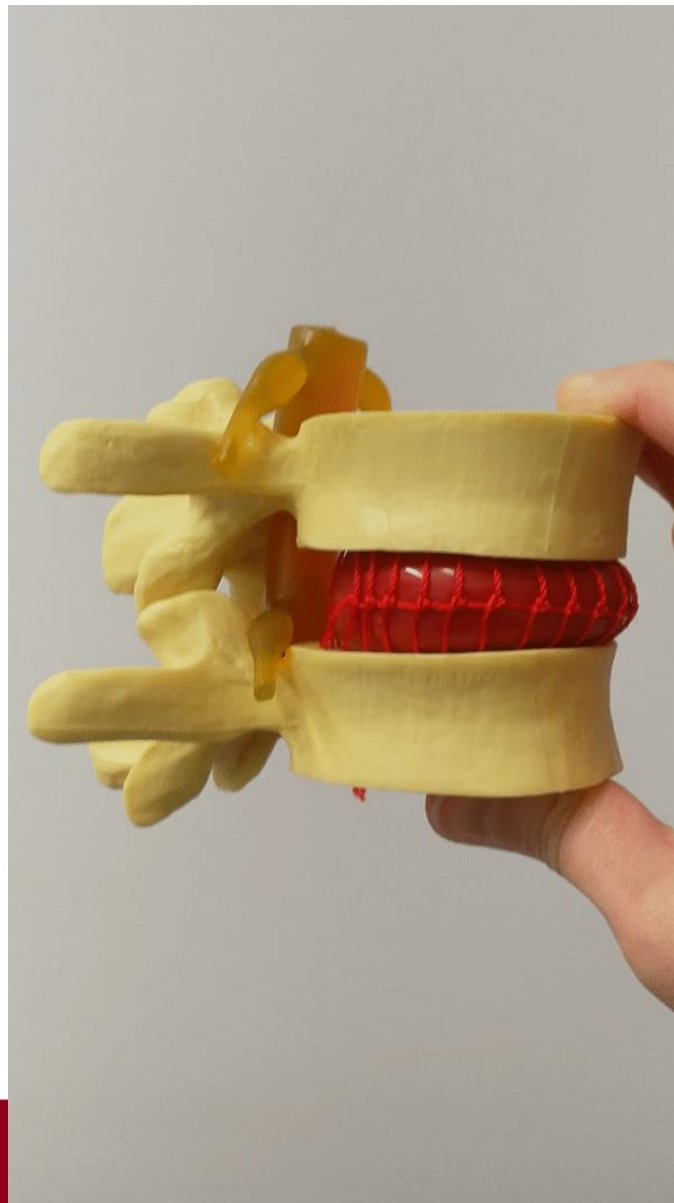

«Taisnas» muguras efekts

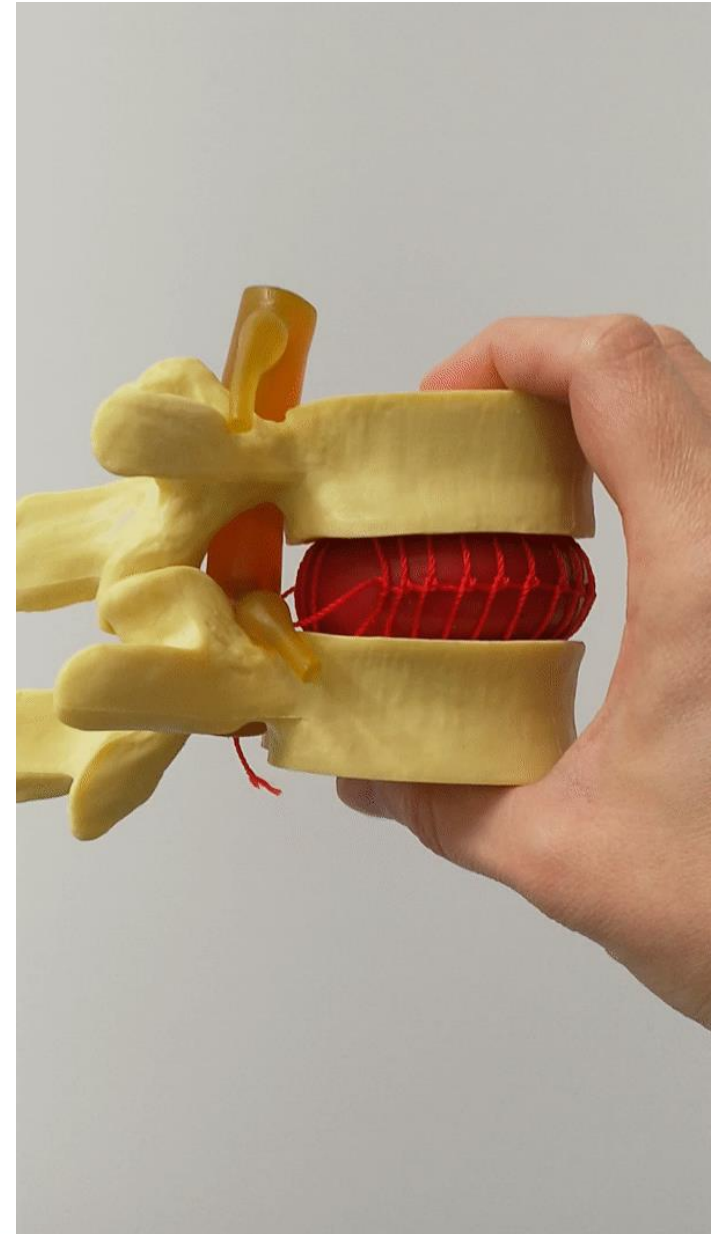
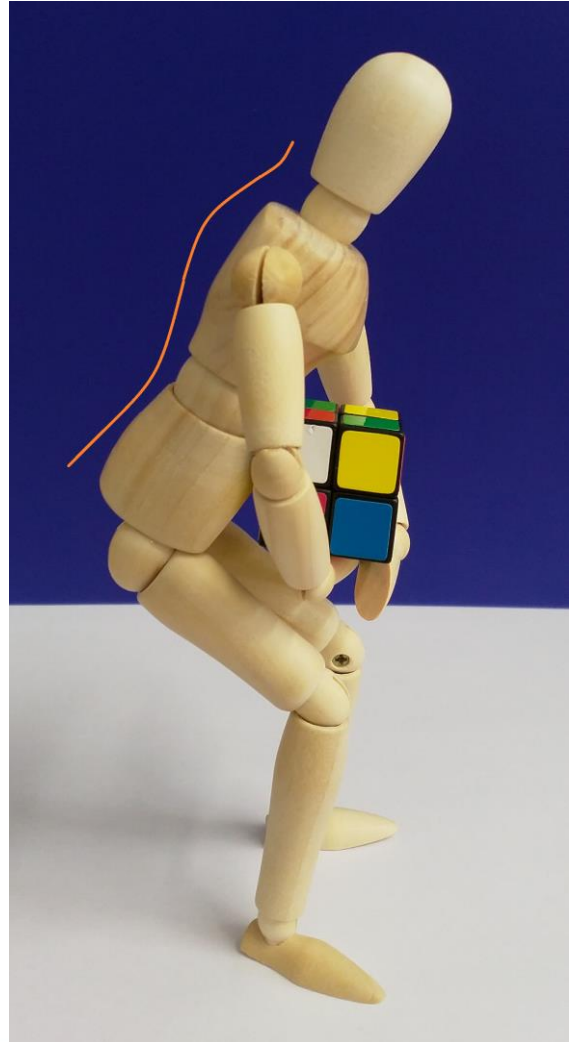

Vēnu varikoze

Normal vein

Varicose vein

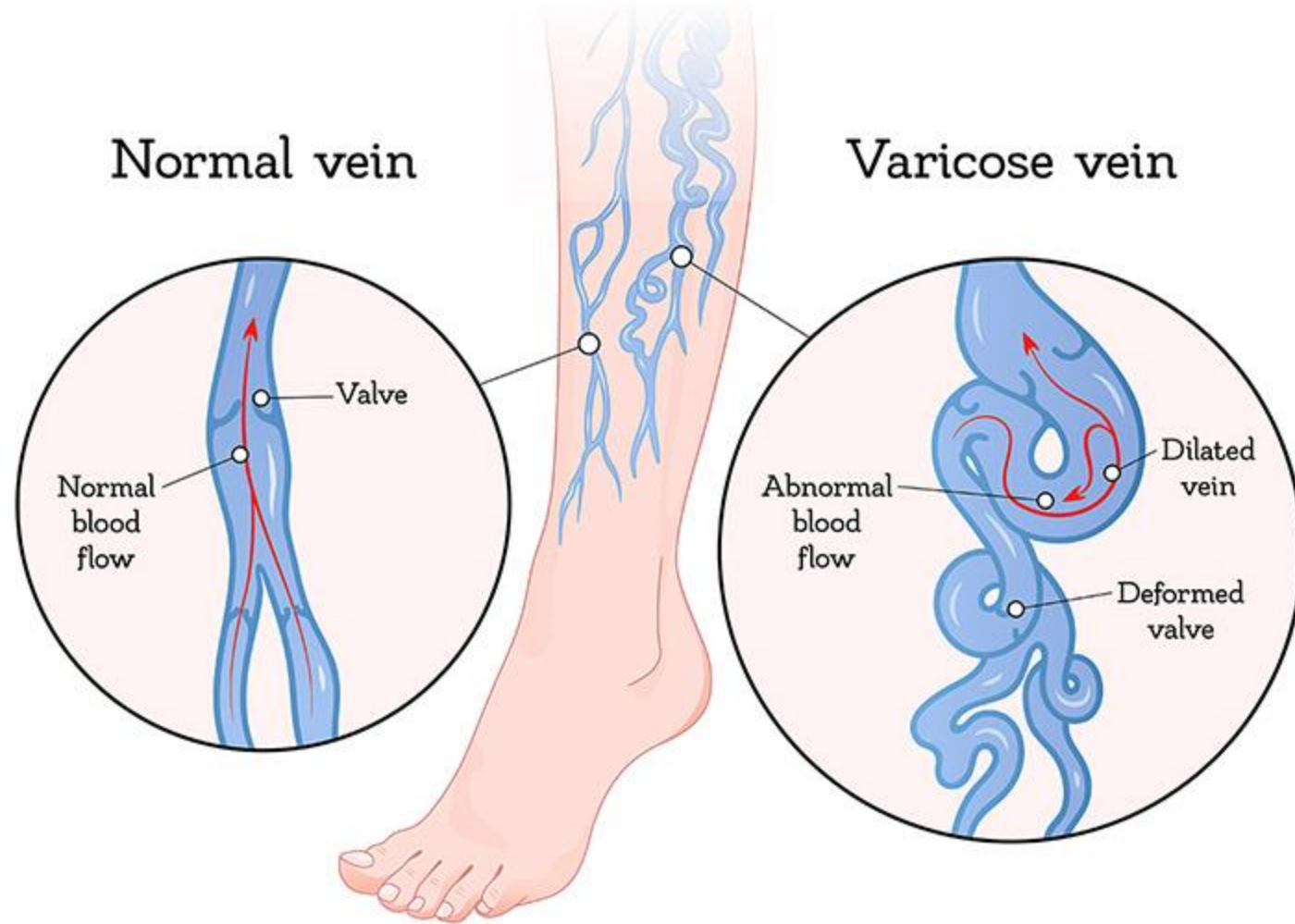

Plantārais fasciīts

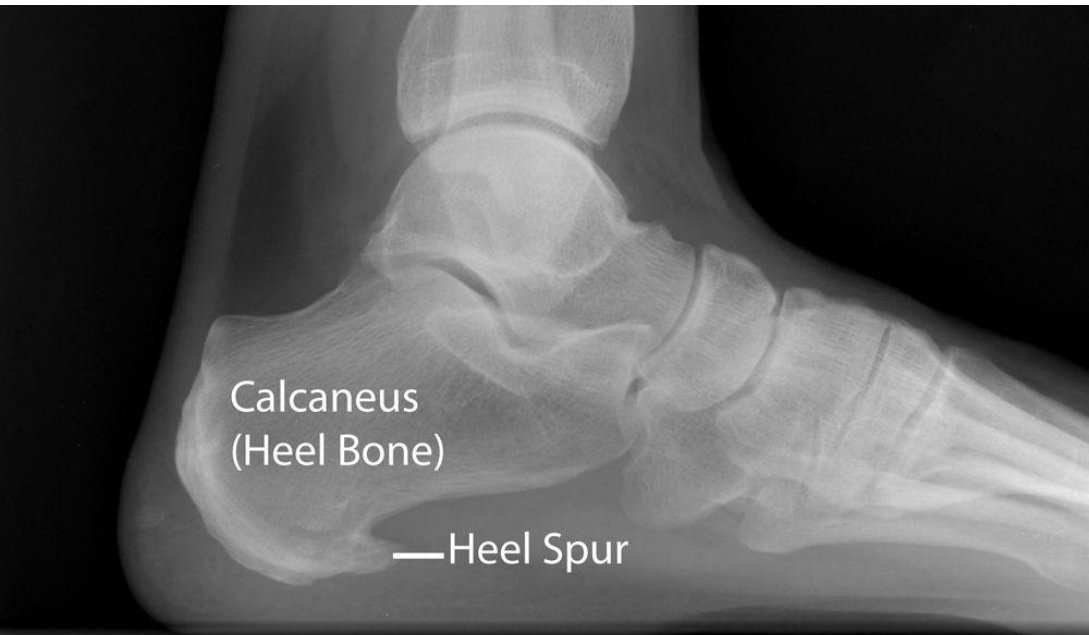
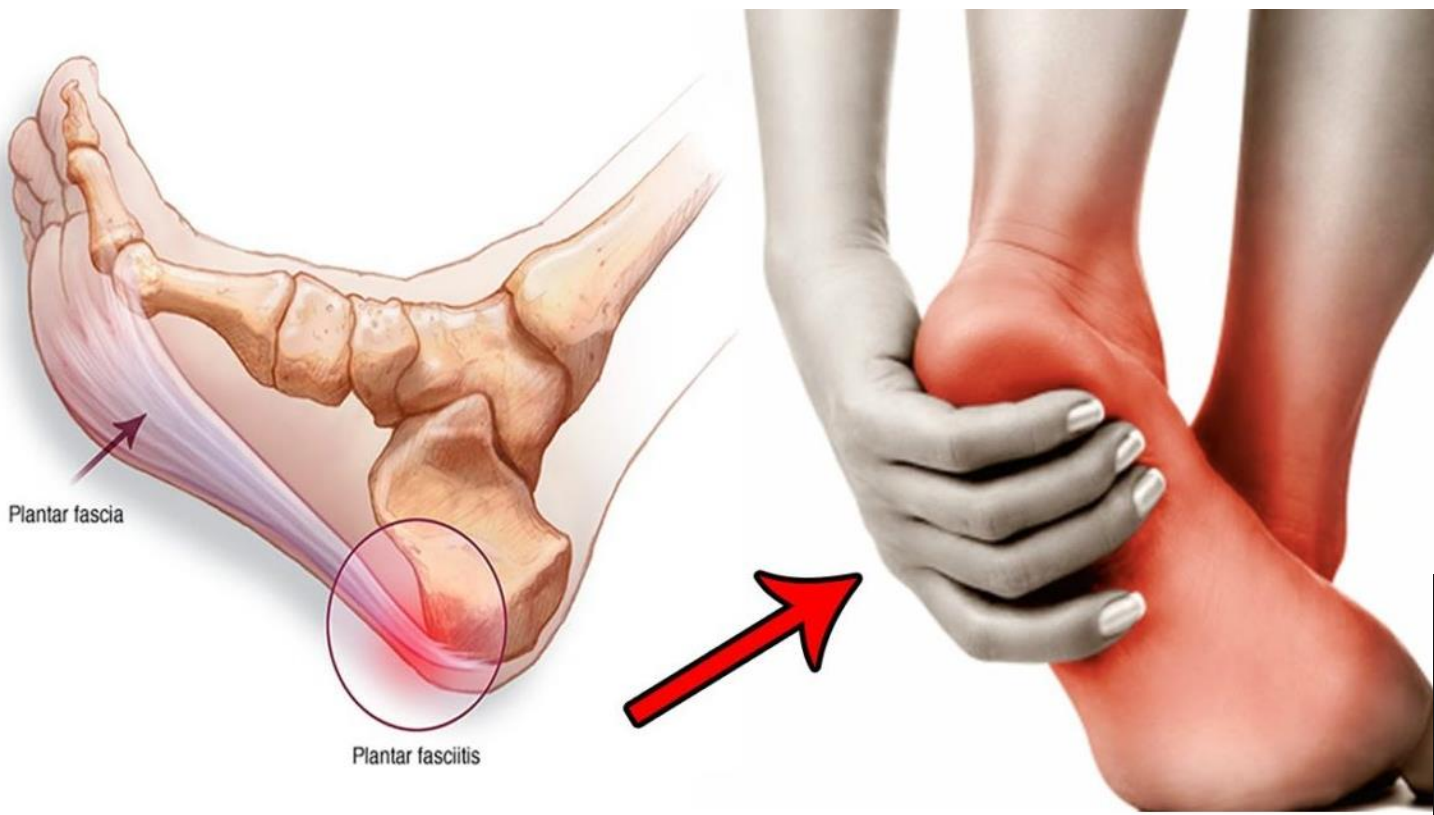

Ergonomisko risku izraisīto MSS arodslimību profilakse

- Laba darba vietas un darba paņēmienu ergonomika (apmācīts personāls)
- Pietiekams laiks atpūtai
- Pozitīva attieksme pret darbu
- Iesildīšanās pirms darba uzsākšanas
- Bieža stiepšanās vingrinājumu izpilde
- Pietiekama organisma hidratācija (šķidruma uzņemšana)
- Stresa mazināšana darbā un mājās
- Nodarbošanās ar veselīgu sportu brīvajā laikā
- Regulārās obligātās veselības pārbaudes un savlaicīga ārstēšanas uzsākšana
- Laba vispārējā veselība

Ergonomikas pamatlikumi
Ergonomisko risku novērtēšanas
paņēmienu, novēršanas un uzlabojumu
iespējas

10 ergonomikas likumi

1. Strādā neitrālajās pozās
2. Samazini lieko piepūli/spēku
3. Izvietoj visu tā, lai būtu viegli sasniedzami
4. Strādā uz atbilstoša augstuma virsmām
5. Samazini liekas kustības
6. Samazini nogurumu un statisko slodzi
7. Samazini spiediena punktus
8. Nodrošini brīvu vietu kustībām
9. Kusties, vingro un pastiepies
10. Uzturi komfortablu vidi



People come in different shapes and sizes.

MacLeod, Dan. The Rules of Work: A Practical Engineering Guide to Ergonomics, 2nd ed.

Cilvēki nāk dažādās formās un izmēros.



Neitrāla ķermeņa pozīcija

- Tāda ķermeņa poza, kura prasa vismazāko muskuļu spēka pielietojumu tās noturēšanai un izraisa vismazāko ķermeņa struktūru noslogojumu.
- Neitrāla pozīcija parasti ir aptuveni katras locītavas pilna kustību apjoma viduspunktā.

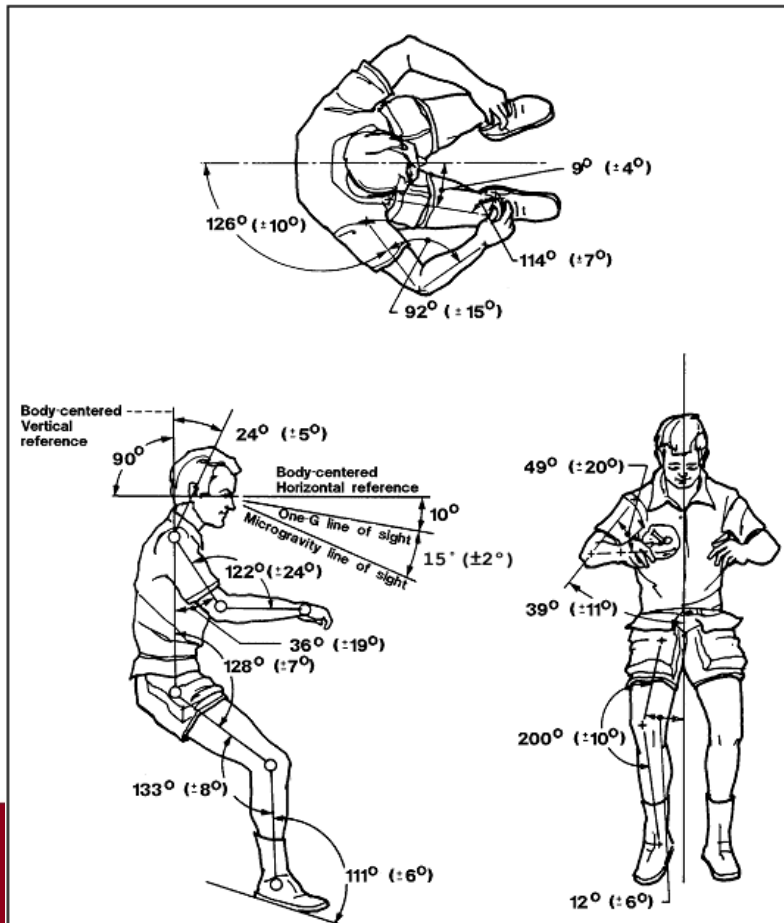

Anatomiski

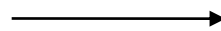

Bez gravitācijas ietekmes



Plaukstu kustību ergonomika

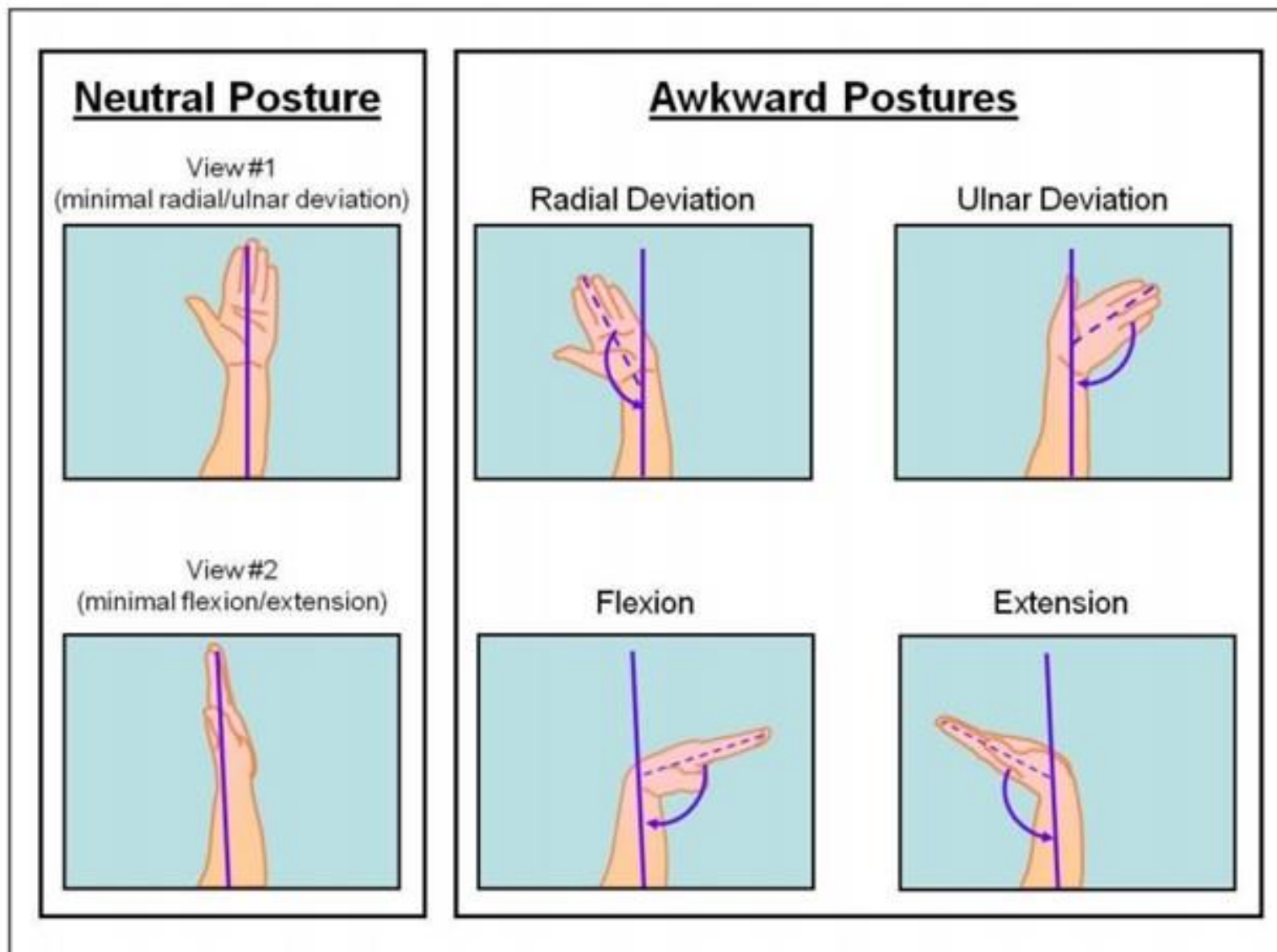

Ergonomisko palīglīdzekļu piemēri

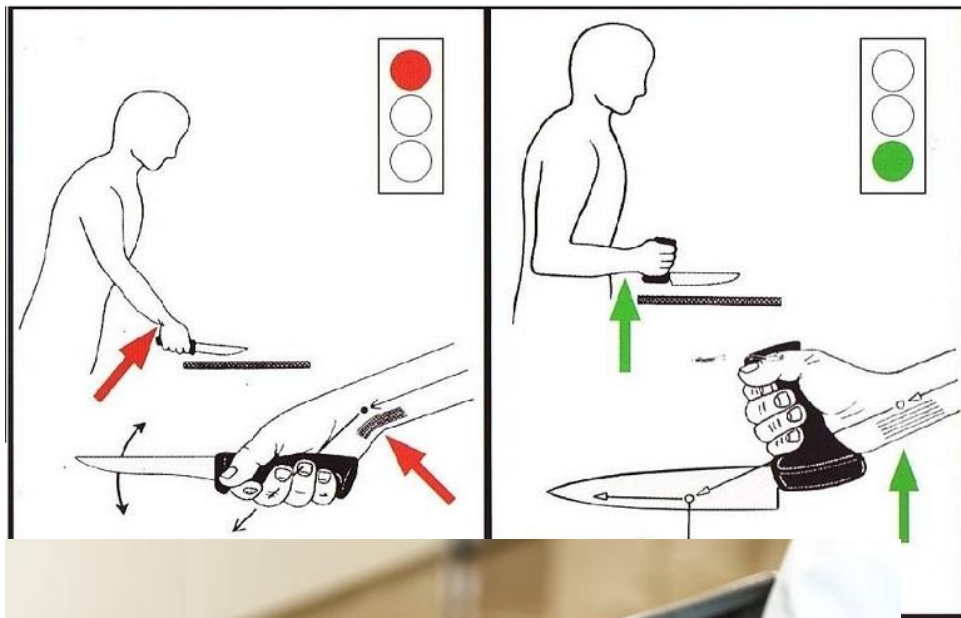

Satvēriena lielums



Satvēriena spēks

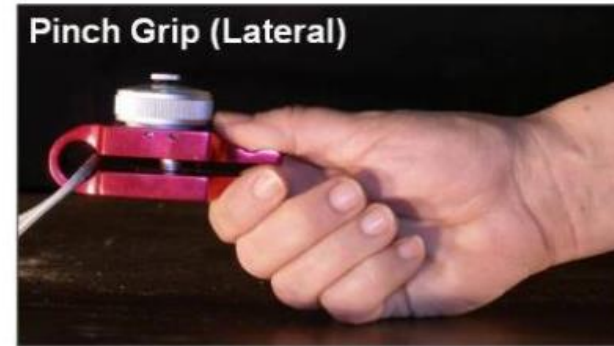

Ergonomisko palīglīdzekļu piemēri

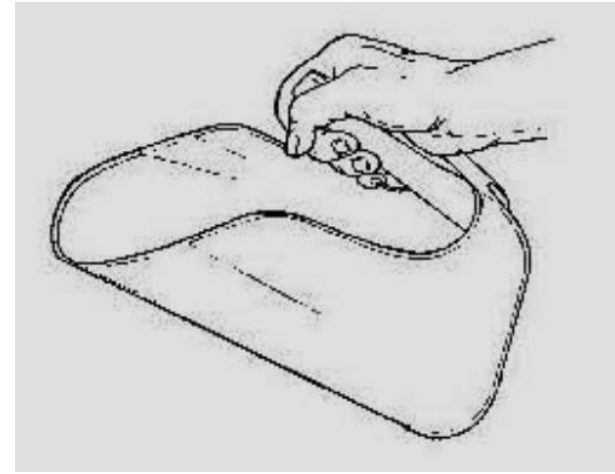
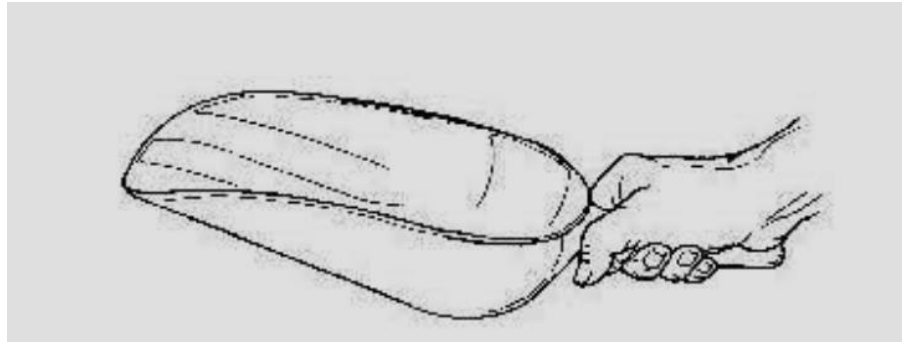

Elkoņa un pleca kustību ergonomika

Neutral Posture

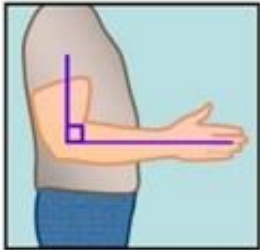

Awkward Postures

Elbow Flexion

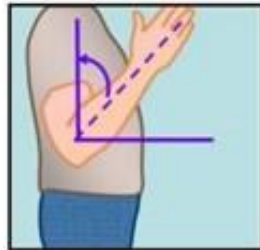

Elbow Extension

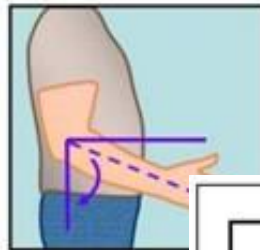

Neutral Posture

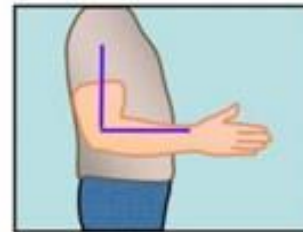

Shoulder Flexion

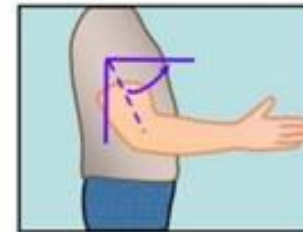

Shoulder Extension

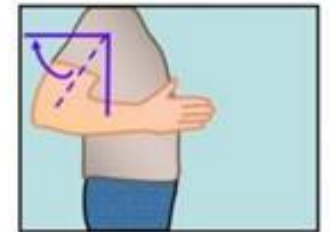

Shoulder Abduction



Shoulder Abduction & Extension



<http://www.cdc.gov/niosh/mining/UserFiles/works/pdfs/2011-191.pdf>

Rokas novietojums uz darba virsmas

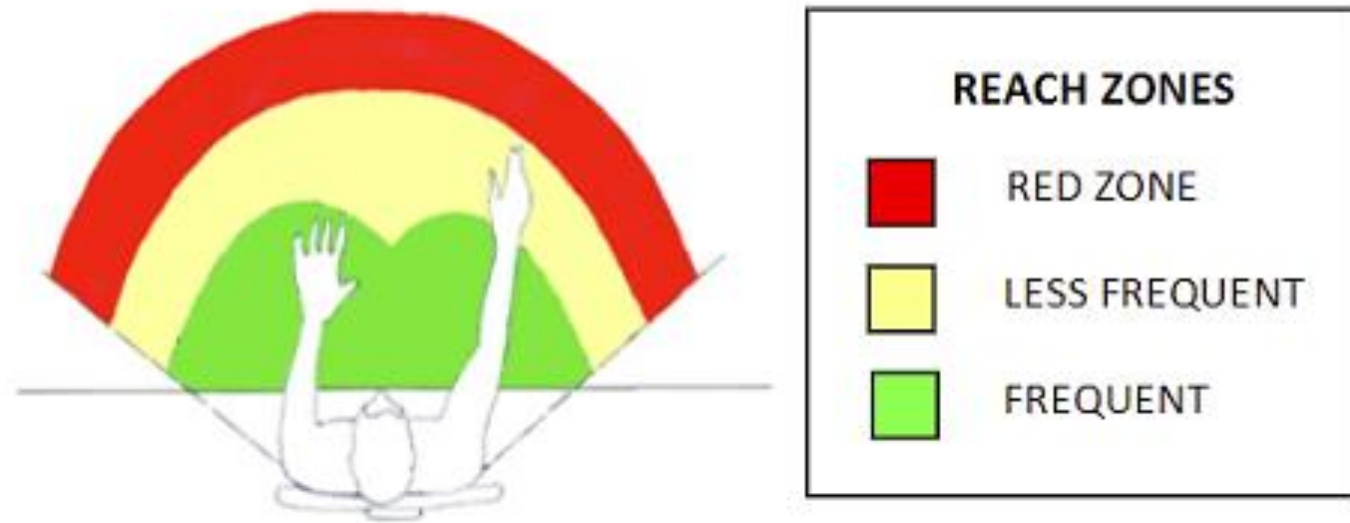

Plecu kustību ergonomika



<http://www.danmacleod.com/ErgoForYou/Principles%20Images/01%20arms,%20cylinder%20line.gif>



BAD DESIGN

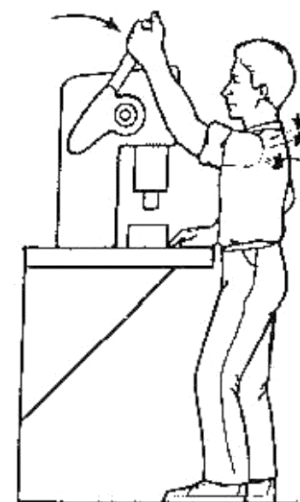

Remove barriers



Cutout



GOOD DESIGN

Mugurkaula kustību ergonomika

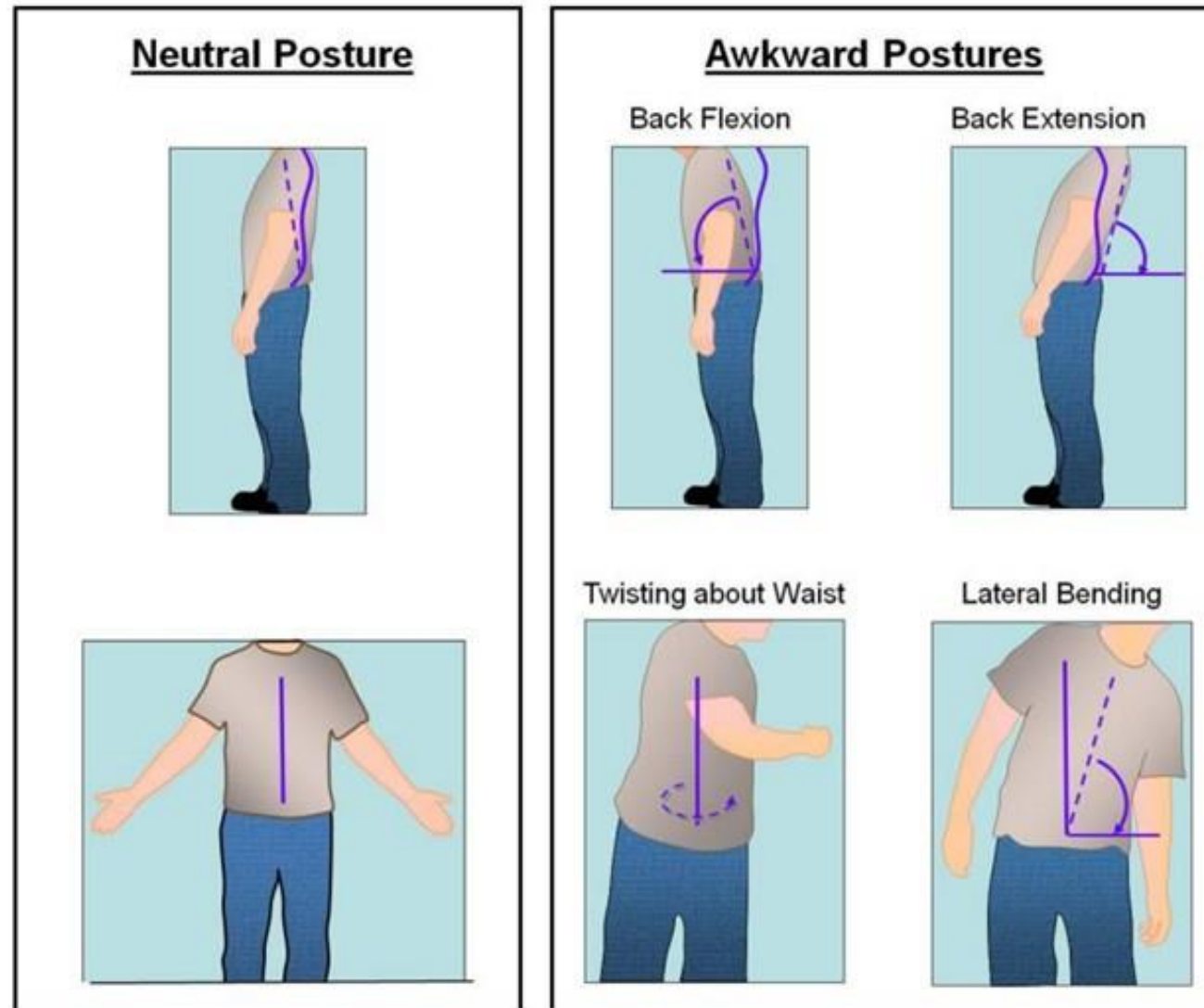

Īpašs risks, pārvietojot smagumus

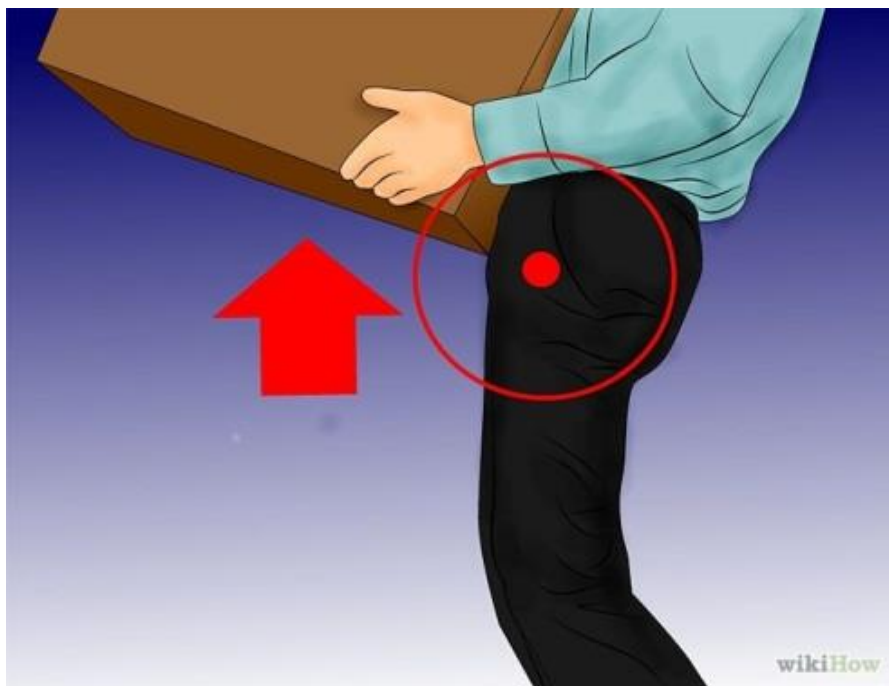

- ✓ neērta (pārāk liela, smaga, grūti satverama, nestabila, saturs var pārvietoties, slidenām virsma (eļļas, smērvielas u.c.)) krava
- ✓ jātur izstieptās rokās
- ✓ jāpārvieto saliecoties vai pagriežoties
- ✓ nepiemēroti pārvietošanas attālumi un virsmas (vertikāli, horizontāli)
- ✓ nepiemērots darba temps (ātrs, nemaināms)
- ✓ nepiemēroti individuālie aizsardzības līdzekļi, apģērbs un apavi
- ✓ neapmācīts darbinieks

Pareiza smagumu pārvietošana

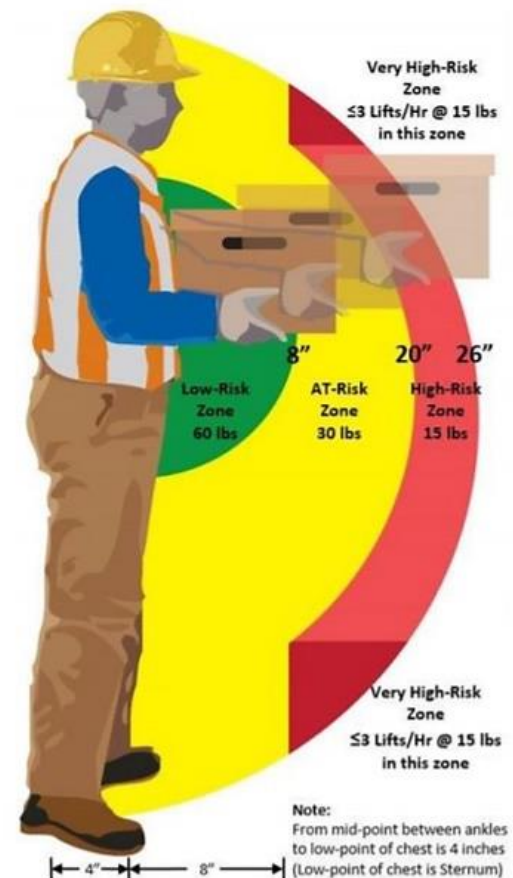

Avots: <https://ehs.stanford.edu/wp-content/uploads/safe-lifting.jpg>

	Woman		Man	
	B	A	A	B
Shoulder height	3kg	7kg	10kg	5kg
Elbow height	7kg	13kg	20kg	10kg
Knuckle height	10kg	16kg	25kg	15kg
Mid lower leg height	7kg	13kg	20kg	10kg
	3kg	7kg	10kg	5kg

= Safe Zone

Avots: <http://www.dontpanicyouareonlymoving.com/the-diy-mover/safe-lifting-tips>

Smagumu nemechanizētas pacelšanas tehnika



Cik vien iespējams jāizvairās no smagumu celšanas no grīdas! Ja tomēr nepieciešams celt no grīdas, nedrīkst saliekties jostas daļā.

Uzmanību!
Šis paņēmiens var būt efektīvs tikai, ja paceļamais objekts ir neliels, viegls un var viegli ietilpt starp ceļiem.



Turiet smagumu tuvu ķermenim un celiet ar kāju spēku

Smagumu nemehanzētas pacelšanas tehnika



Lean the sack onto your kneeling leg.



Slide the sack up onto your kneeling leg.



Slide the sack onto the other leg while keeping the sack close to your body.



As you stand up, keep the sack close to your body.



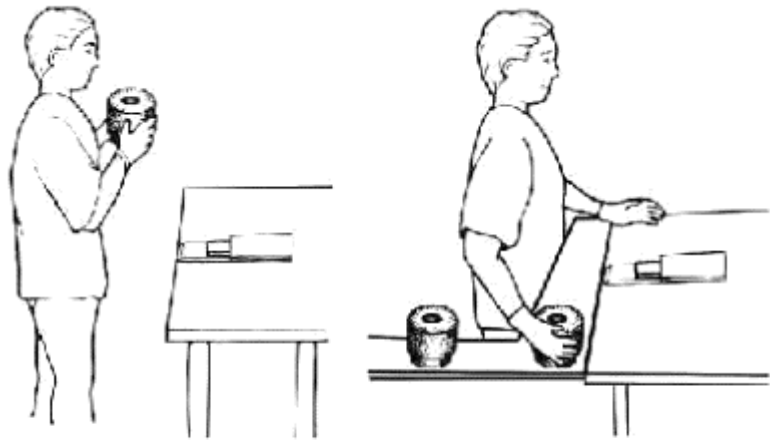

Slide surfaces — Low cost and effective

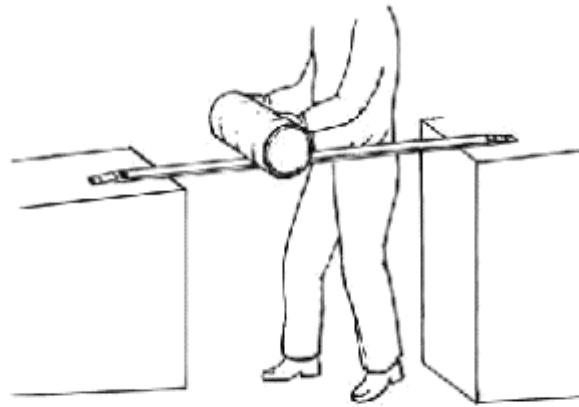

Slides can be configured at low cost in spots where standard conveyors do not fit.

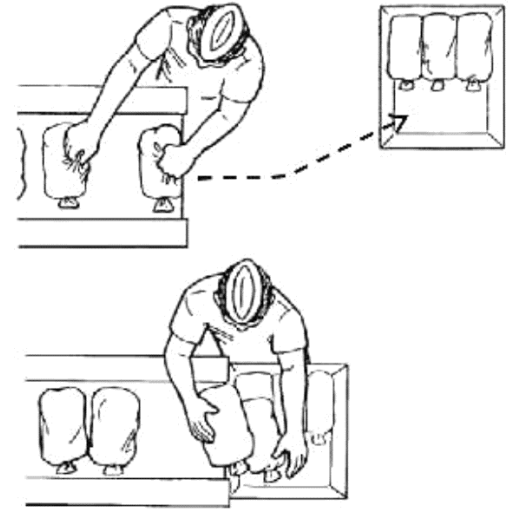

Pay attention to layouts and distances moved.

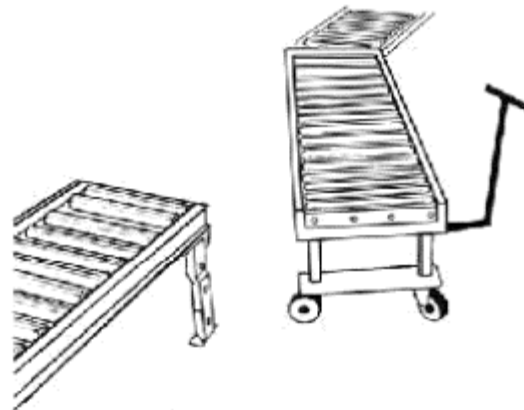

Hinged gate and handle

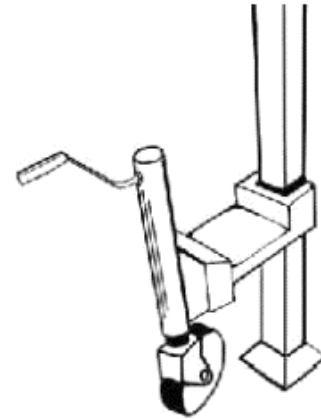

Detachable wheel

Smagumu pārvietošana



Smagumu pārvietošanas automatizācija un atvieglošana



<https://youtu.be/GqWaJZ0UFAw>



<https://youtu.be/Zf86VP-tWcQ>

Smagumu pārvietošana

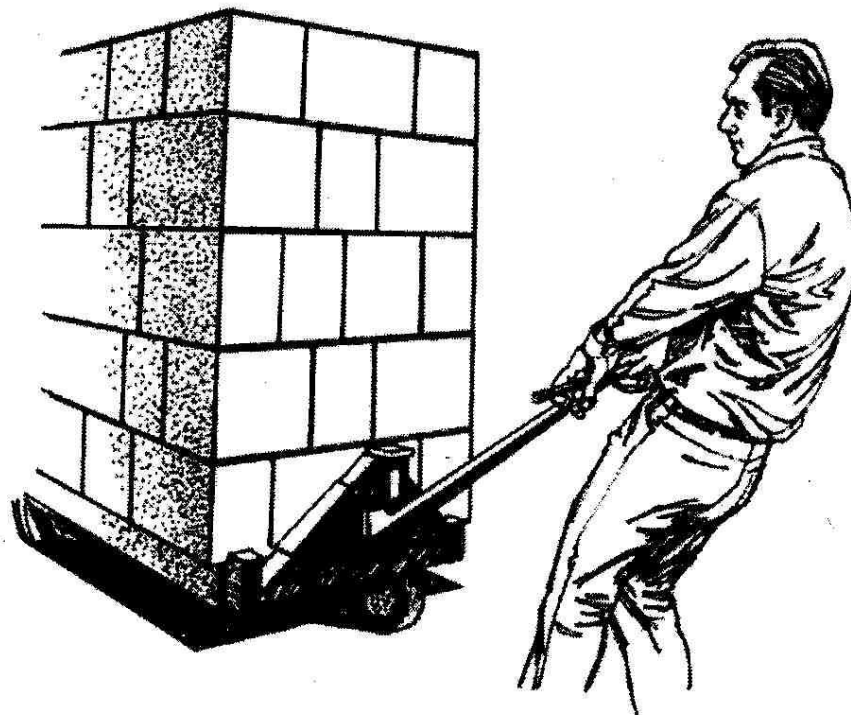
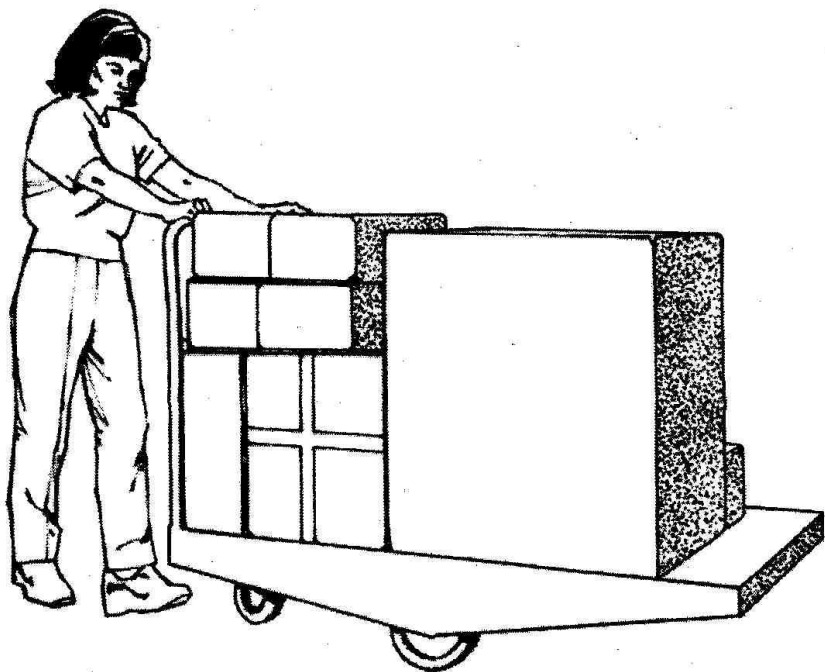

Veselīgāk ir stumt, nevis stiept!



Mehanizēta smagumu pārvietošana



https://youtu.be/rycfK_8o0lk

Darba virsmas augstums

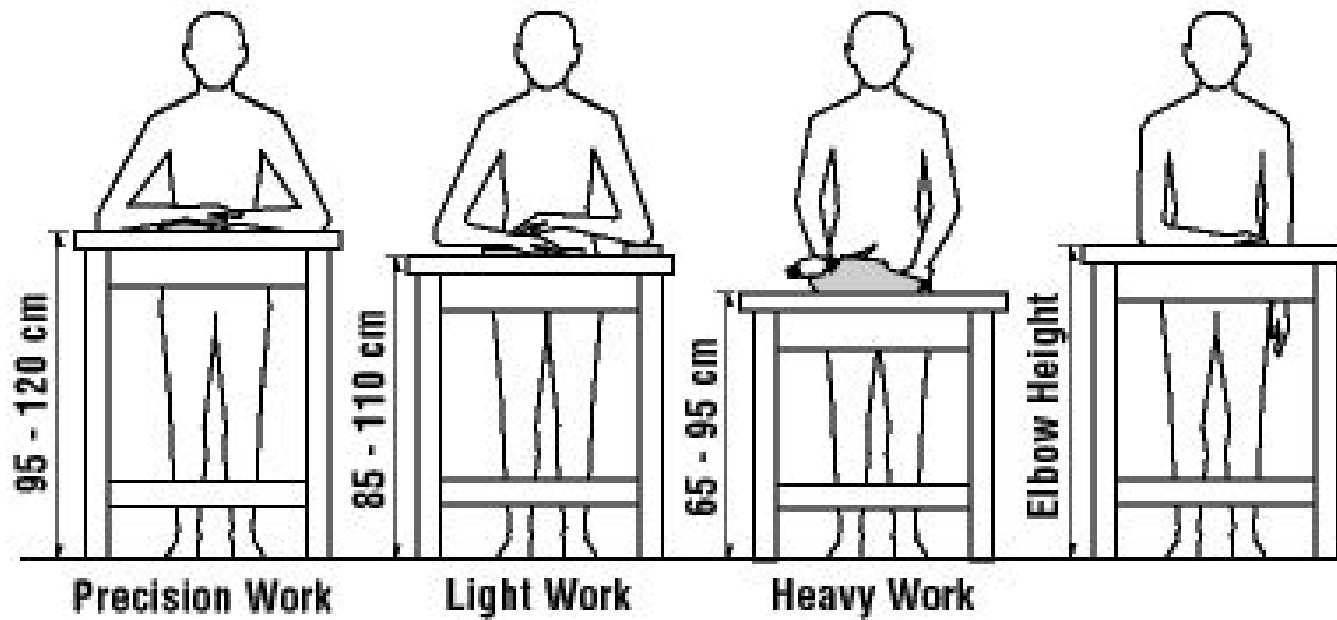

<https://s-media-cache-ak0.pinning.com/564x/ff/15/de/ff15de6501b71ab55463c0ee02391732.jpg>

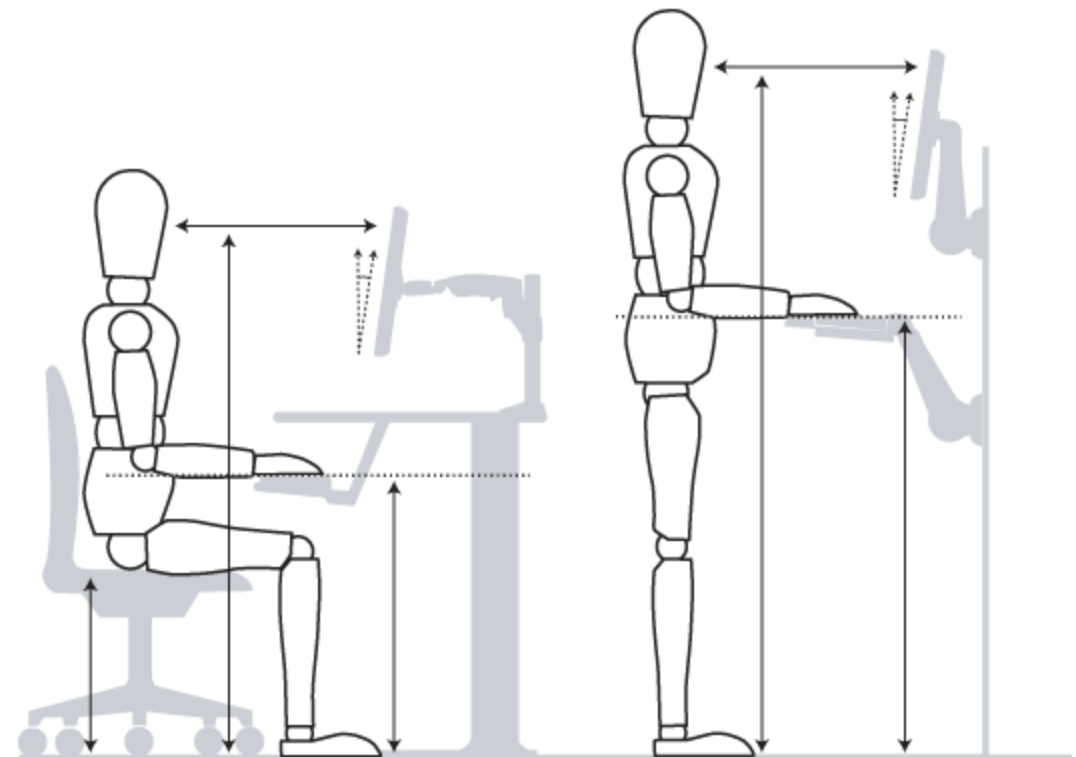

Darba virsmu augstuma pielāgošana

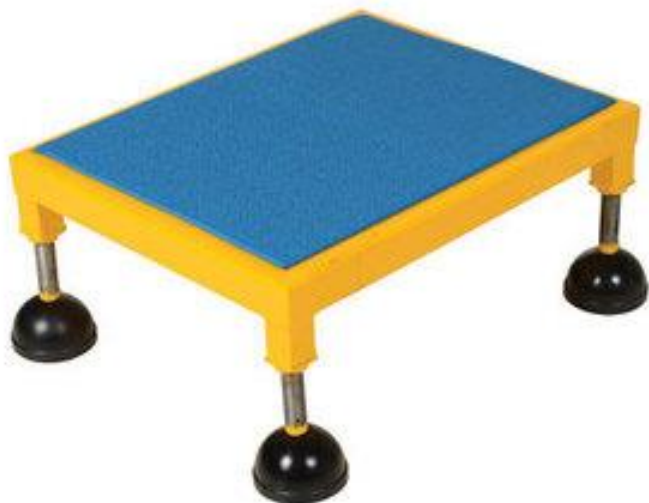

Darba virsmu augstuma pielāgošana



Atkārtota noliekšanās

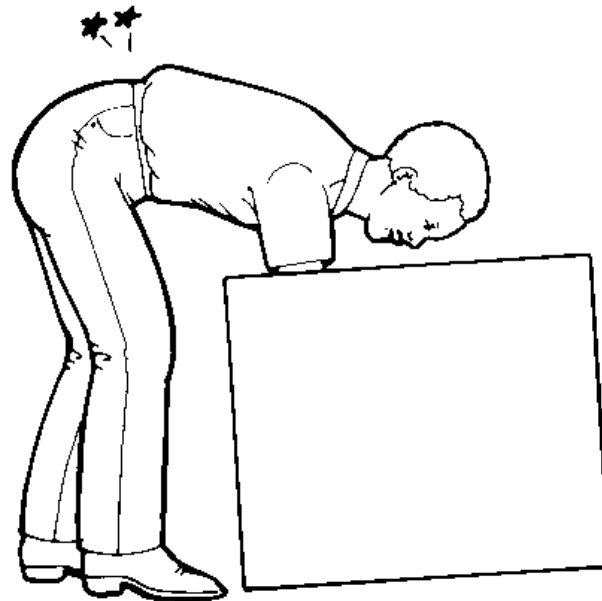

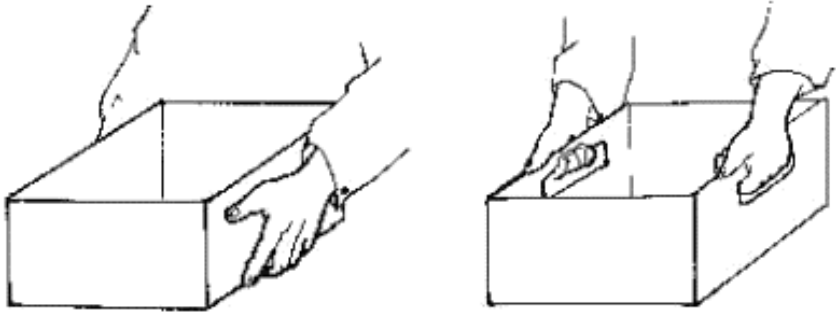

Handholds enable use of a power grip, which reduces effort.

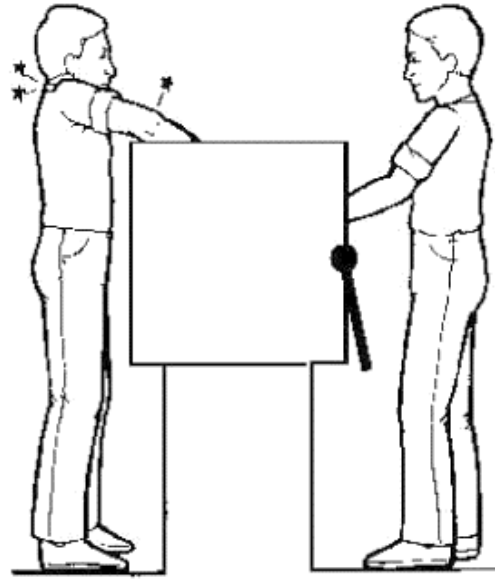

Container with drop down side



More motions



Fewer motions

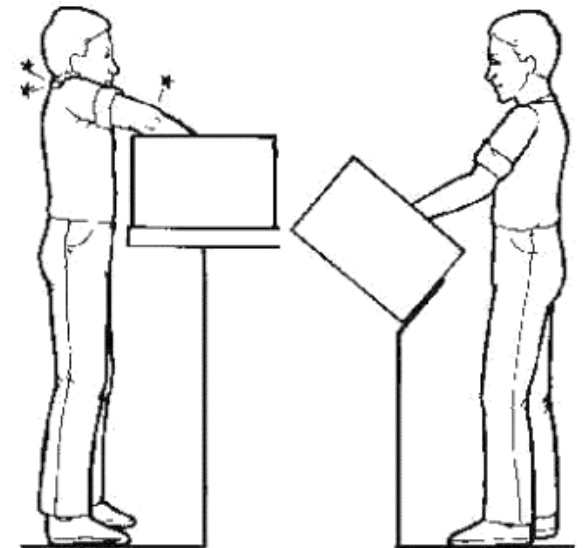

Tilting container stands is one of the most common, low-cost ways of reducing reaches.

Nogurdinošs darbs stāvus - risinājumi

Ērti apavi



Kompresijas zeķes



Speciālie amortizējošie paklāji



Ortopēdiskas zolītes



**Atpūtas paužu laikā apsēsties,
pacelt kājas augšā.**



Risinājumi stāvēšanas atvieglošanai



Sēdēšana darba laikā



SY-CP10



SY-CP11



SY-CP12



SY-CP13



SY-CP14



SY-CP15



SY-CP16



SY-CP17



SY-CP18



Mugurkaulam ir svarīgi uzturēt pareizos izliekumus darba laikā

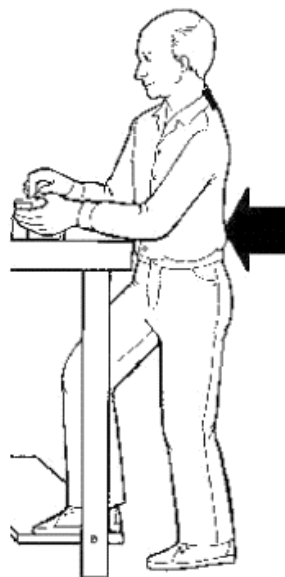

Keep the S-curve, whether sitting or standing.

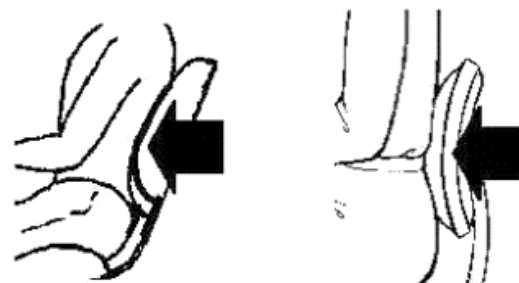

Good lumbar support

Skrejratī



Eksoskeleti



Tīrīšanas un uzkopšanas darbu optimizēšana





Risinājumi displeju novietošanai



Darba vietas ergonomikas novērtēšanas paņēmieni

- Darbinieku aptauja par diskomfortu un sāpēm darba laikā/pēc darba
- Filmēšana/fotogrāfiju uzņemšana un analīze
- Speciālas novērtēšanas programmas (piem., *RULA (Rapid Upper Limb Assessment)*, *Strain Index*, *REBA (Rapid Entire Body Assessment)*, *TAPDA*, *NIOSH The Work Practices Guide for Manual Lifting*).
- Ergonomikas novērtēšana, pielietojot speciālu aparatūru



Darbinieku aptauja

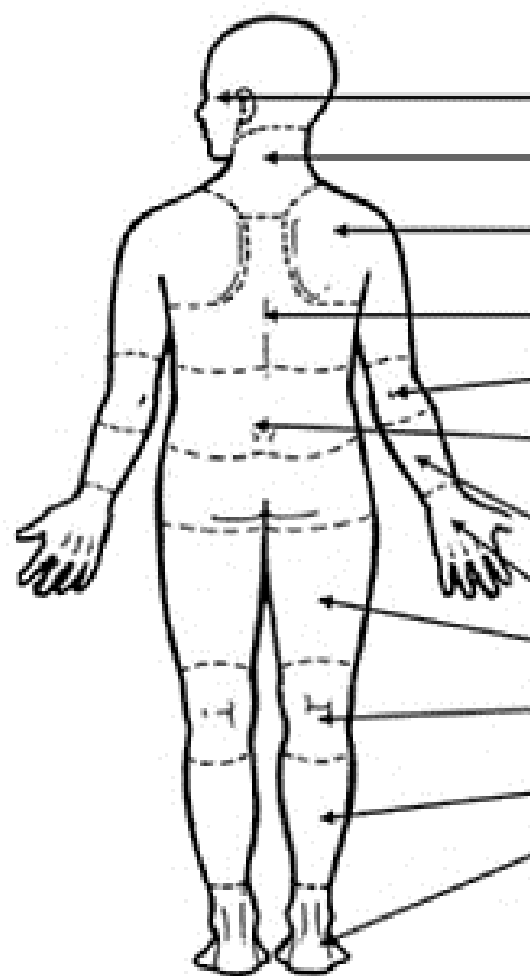

Extremely Comfortable ← → Extremely Uncomfortable

Eye	1	2	3	4	5
Neck	1	2	3	4	5
Shoulder	1	2	3	4	5
Upper Back	1	2	3	4	5
Elbow	1	2	3	4	5
Lower Back	1	2	3	4	5
Arm	1	2	3	4	5
Wrist/Hand	1	2	3	4	5
Thigh	1	2	3	4	5
Knee	1	2	3	4	5
Calf of leg	1	2	3	4	5
Feet/Ankle	1	2	3	4	5

Pain Point aplikācija mobilajam tālrunim



<https://www.ohcow.on.ca/resources/occupational-health-toolkits-and-apps/painpoint/>

Praktiska mobilā aplikācija, lai atvieglotu darbavietas ergonomikas novērtēšanu

- Ergonomic checkpoints. Practical and easy-to-implement solutions for improving safety, health and working conditions. ILO, 2nd edition, 2010
- Ergonomic Checkpoints app
https://www.ilo.org/safework/info/publications/WCMS_438082/lang--en/index.htm
- Ergonomisko risku novērtēšanas instrumenti

<https://books.hse.gov.uk/>

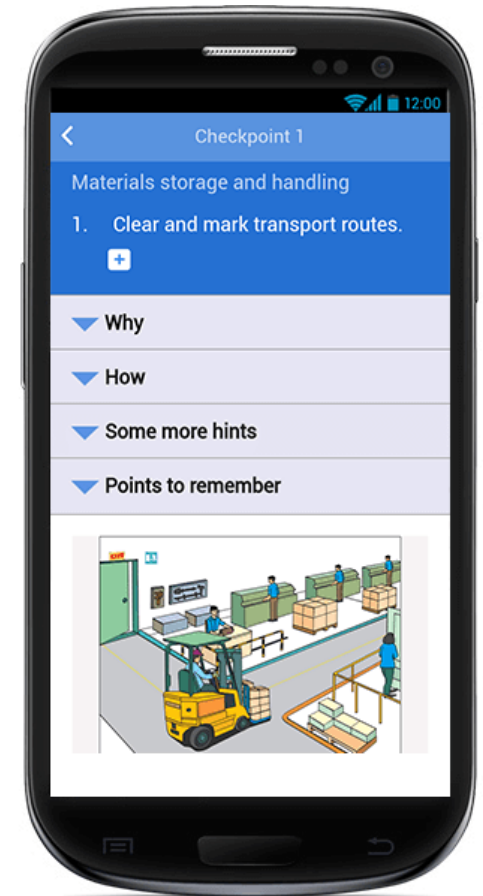
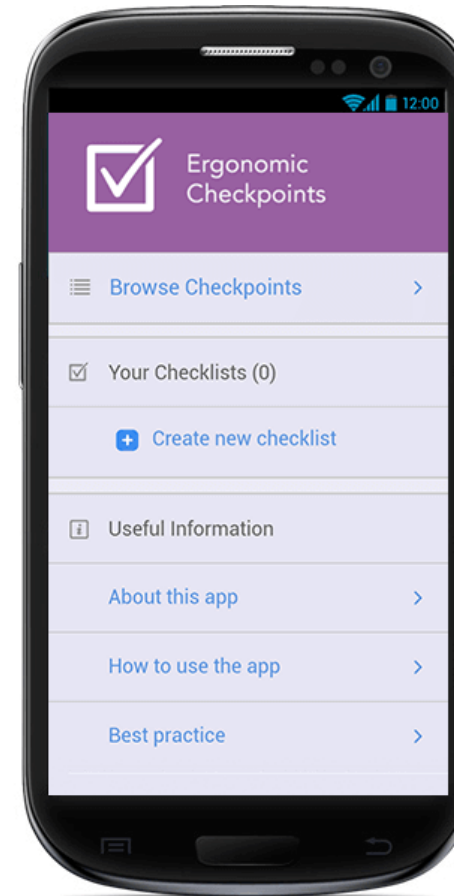

Ar darbu saistīto veselības traucējumu profilakse

- darba aizsardzības prasību ievērošana;
- individuālo aizsardzības līdzekļu izmantošana;
- darba vietas ergonomikas uzlabošana (individuāla pieeja!!!);
- darbinieku apmācība pareizajiem darba paņēmieniem,
- darba kustību atstrādāšana, lai **minimalizētu nevajadzīgo kustību skaitu**,
- darba režīma samērošana ar darbinieka spējām;
- darba rotācija;
- atpūtas paužu veselīga izmantošana;
- regulāras obligātās veselības pārbaudes, kurās darbiniekam **jāsūdzas par veselības problēmām un nedrīkst slēpt veselības traucējumus**;
- Gadījumā, ja rodas kādas veselības problēmas, pēc iespējas ātrāk griezties pie ārsta un **negaidīt līdz neizturamai situācijai!**

Paldies par uzmanību!



Stiepšanās vingrinājumi darbā

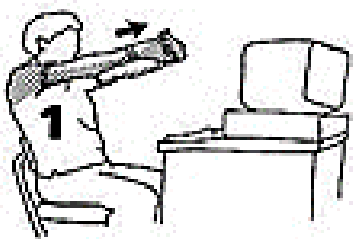

10-20 seconds
2 times



10-15 seconds



8-10 seconds
each side



15-20 seconds



30 seconds

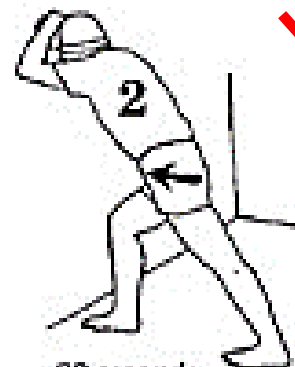

20 seconds
each leg

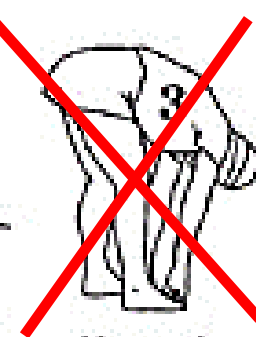

20 seconds

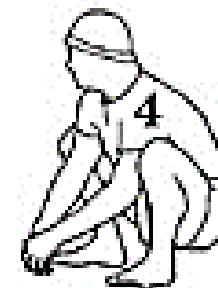

20 seconds

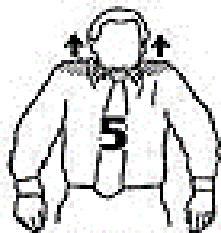

3-5 seconds
3 times



10-12 seconds
each arm



10 seconds

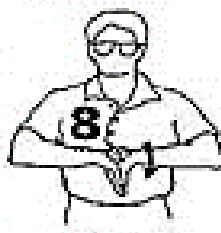

10 seconds

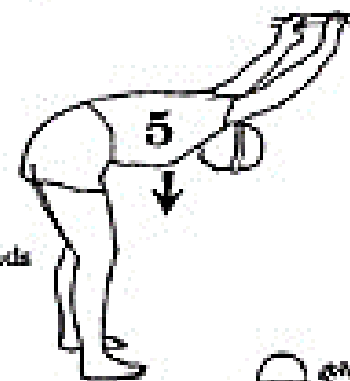

15 seconds



2 times
10 seconds each



8-10 seconds
each side

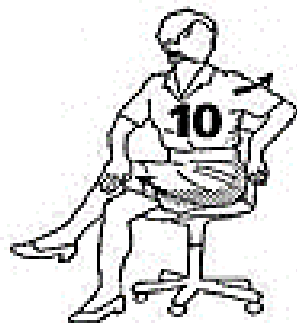

8-10 seconds
each side

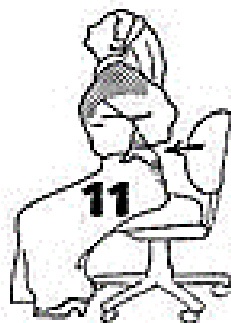

10-15 seconds
2 times

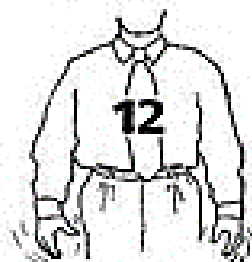

Shake out hands
8-10 seconds



10 seconds
each arm



5 times
each direction

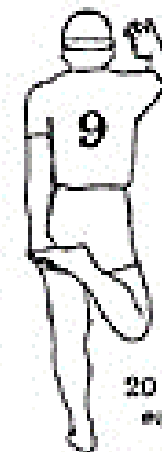

20 seconds
each leg

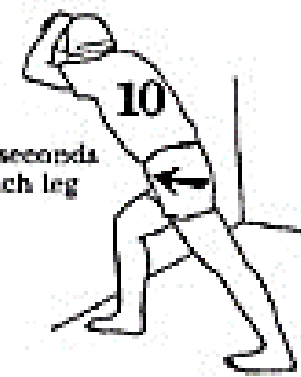

20 seconds
each leg